

Date tehnice pentru produs: MGF57005-A

Ampermetru 72*72mm, 5A, conexiune directă, AC



Fișe tehnice

Standard	EN 50081 BS-89 VDE 0410 EN 60051 EN 50082 EN 61010
Tip	panou frontal
Afișaj	analog
Domeniu măsură	5A
Mărime	72x72mm
Domeniul de frecvență	15-100Hz
Accuracy	1,50 percent
Overload (continuous)	1,5 I _n
Overload (short-time)	5 I _n 30s, 10 I _n 5s, 40 I _n 1s
Isolation test voltage	2 kV R.M.S 50 Hz/1 min
Reference temperature (°C)	+10 bis +30
Gama de temperatură - Transport/Depozitare (°C)	-25 to +40
disipare (W)	1,20

Fișe tehnice - Continuare

Metodă de montaj	Instrument for vertical mounting
grad de protecție	IP52 (front), IP00 (connections)
Burden	0,4VA
Rezistența la vibrații	VDE 0410, 2,5g, ±0,25mm, 50Hz
Rezistența la șoc	VDE 0410, 15G

Schema electrica: Ampermetru 72*72mm, 5A, conexiune directă, AC

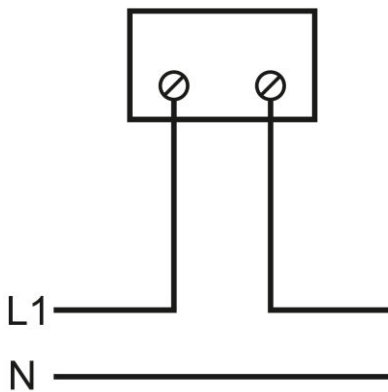

Desen dimensional: Ampermetru 72*72mm, 5A, conexiune directă, AC

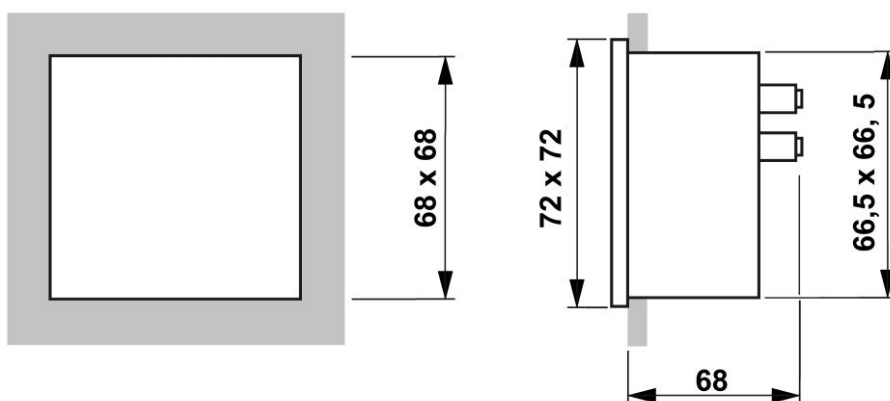

Descriere	Cod comandă
Ampermetru 72*72mm, 5A, conexiune directă, AC	MGF57005-A