

Date tehnice pentru produs: MG954030-A

Transformator de curent 300/5A, 30x10, clasă 0,5



Fișe tehnice

Notă

The converter is not allowed to be operated with open secondary side, because this leads to a dangerous overvoltage at the secondary side and overheating of the converter!!! (EN60044-1/A2)
Therefore, when disconnecting the measuring device, meter or power analyzer, short-circuit the secondary side.

Intended use	for cables up to diameter 27mm for copper bars up to 30 x 10mm
Standard produs	EN 61869-2
Decupaj mm (mm)	30x10
Specifications	
Rated current primary side I _{pr} (A)	300
Rated frequency (Hz)	50
Domeniul de frecvență	47 - 63Hz
Thermal rated continuous current according to EN60044-1	
Short-time current I _{th}	< 60I _{pr}
Rated dynamic current I _{dyn}	2.5I _{th}
Safety factor	≤ 5
Rated current secondary side I _{sr}	5A

Fișe tehnice - Continuare

Thermal power loss	≤ 7W at I _{cth} 125°C Maximum temperature cable/busbar.
Insulation requirements	
Versiune	Dry type transformer, air insulation
Max. Operating voltage U _m	0.72kV r.m.s.
Isolation test voltage	3 kV R.M.S. 50 Hz/1 min
Isolation	Class B (EN60044-1)
Working conditions	
Categorie produs	Normal installation (DIN EN 61869-2)
Reference temperature (°C)	23°C ±1°C
Gama de temperatură - Funcționare (°C)	-25 la +50
Daily average temperature	≤ 30°C
Gama de temperatură - Transport/Depozitare (°C)	-40 to +85
Umiditate relativă (%)	≤ 85
Condiții climatice	Suitable for tropical climate
Carcasă	
Housing material	Polycarbonate, self-extinguishing Class V0 according to UL-94
grad de protecție	IP20
Metodă de montaj	screwable for wall mounting snap-on DIN rail 35 mm
DIN rail	TH35-15 (EN60715)
Masă g	260
Conexiune	
Winding primary side	Continuous cable
Torque	busbar fixing: 0,2Nm
Winding secondary side	Screw terminals
Terminal labeling	Winding secondary side s1(k) - s2(l) Winding primary side P1(K) - P2(L)
Accuracy classes	
Load current error	For class 0.5 and 5% I _n : ±1.5% For class 0.5 and 120% I _n : ±0.5% For class 1 and 20% I _n : ±1.5% For class 1 and 5% I _n : ±3%. For class 0.5 and 100% I _n : ±0.5% For class 0.5 and 20% I _n : ±0.75% For class 1 and 100% I _n : ±1%. For class 1 and 120% I _n : ±1%
Burden	Class 0.5 (8VA) Class 1 (10VA)

Schaltbild

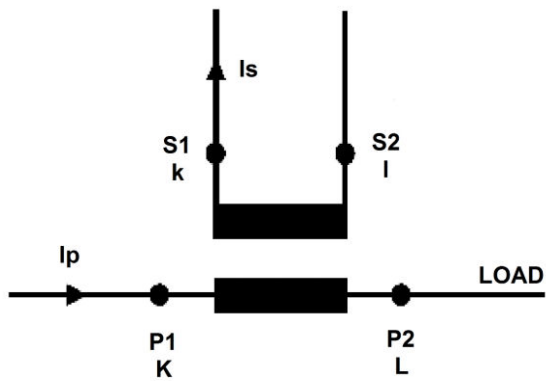

Maßbild

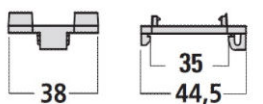
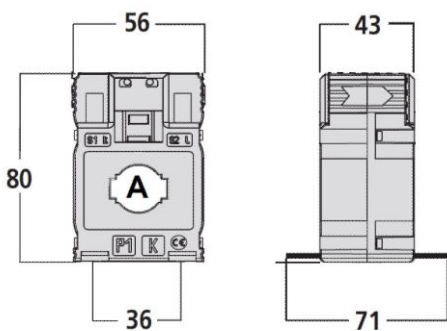

DIN-Schienen-Montage
DIN rail mounting

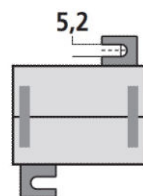

Schraubbefestigung
Screw type mounting



SCHRACK Technik GmbH, AT-1235 Wien, Seybelgasse 13

www.schrack.com

Tabel articole

Descriere	Cod comandă
Transformator de curent 300/5A, 30x10, clasă 0,5	MG954030-A
Accesorii opționale	
Contor digital kWh 1A/5A (6A), 3faze, 2 tarife, MID cerere ATENȚIE: CONSTANTA SE POATE SETA O SINGURA DATA! Măsoară energia consumată și injectată în rețea (2 direcții)	MGX20006
Contor digital kWh 1A/5A(6A), 3f, 2 tarife, MID cerere, M-BUS ATENȚIE: CONSTANTA SE POATE SETA O SIGURA DATA! Măsoară energia consumată și injectată în rețea (2 direcții)	MGX20306
Contor digital kWh 1A/5A (6A), 3f, 2 tarife, MID cerere, Modbus ATENȚIE: CONSTANTA SE POATE SETA O SINGURA DATA! Măsoară energia consumată și injectată în rețea (2 direcții)	MGX20406