

Date tehnice pentru produs: IUKNF3523A

Ventilator cu filtru IP54, 230VAC, 110mc/h, 202x202x87mm



SCHRACK-Info

- Filter ventilators and exhaust filters are injection-moulded from thermoplastic material, self-extinguishing according to UL94VO, UV-resistant
- Toolless mounting with patented 4-corner-catching
- Simple exchange of filter mat thanks to patented and service-friendly hinge system
- Variable direction of air conveyance via 180° rotation of fan-motor assembly, standard as delivered is directing towards the enclosure (not possible for **IUNKF1523A**)
- Fast electrical connection via spring-type terminals
- Degree of protection: IP54 with standard filter mat, IP55 can be reached by using fluted filter mat **IUKM4x20** (not possible for **IUKNF1523A**)
- Color: RAL7035 (Light grey)



Fișe tehnice

Lățime netă (mm)	202,00
Înălțime (mm)	202,00
Adâncime netă (mm)	87,00
Masă netă (kg.)	0,87
Temperatura minimă a mediului ambiant (°C)	-40
Temperatura maximă a mediului ambiant (°C)	55
Culoare	Gri deschis
grad de protecție	IP54
Accesorii opționale	IUKM4710--;IUKM4720--
Capacitate utilă de răcire cu filtru de iesire IP54 (W/K)	23,4
Categorie produs	Ventilator

Fișe tehnice - Continuare

Tensiune nominală	230V-AC
Decupaj mm (mm)	177x177
Adâncime montaj (mm)	87
Cooling output with downstream filter IP55	15,7
Debit aer la IP54 (m ³ /h)	98
Debit aer la IP55 (m ³ /h)	100

Tabel de date: Ventilator cu filtru IP54, 230VAC, 110mc/h, 202x202x87mm

Daten	IP	Einheit	IUKNF								
			1523A	2523A	3523A	4523A	5523A	6523A	7523A	8523A	
Nennspannung ±10%		V	AC 50 / 60Hz								
			230								
Luffördermenge freiblasend	IP54	m ³ /h	19 / 24	61 / 70	110 / 125	125 / 138	223 / 247	480 / 480	640 / 653	845 / 875	
	IP55*		-	56 / 64	100 / 110	145 / 160	233 / 265	505 / 505	770 / 785	925 / 950	
Luffördermenge in Kombination mit Austrittsfilter IUKNExxx	IP54	m ³ /h	12 / 14	44 / 52	82 / 93	93 / 102	201 / 223	370 / 370	445 / 445	560 / 625	
	IP55*		-	40 / 46	55 / 64	109 / 113	180 / 207	380 / 380	490 / 501	570 / 625	
Leistungsaufnahme		W	12 / 11	19 / 18		18 / 17	45 / 39	80 / 100	120 / 160	140 / 197	
Stromaufnahme		A	0,07 / 0,06	0,12 / 0,18		0,12 / 0,10	0,32 / 0,26	0,35 / 0,45	0,53 / 0,72	0,62 / 0,86	
Geräuschpegel EN ISO 3741		dB (A)	33 / 33	44 / 44	40 / 40	40 / 43	53	54 / 52	63 / 64	66 / 69	
Gewicht		kg	0,55	0,70	0,87	1,18	1,67	3,20		3,70	
Anschlussart			Kabel	Klemmleiste		Federreihenklamme					
Absicherung		A	6								
Schutzart	IP54		NEMA Typ 12 - Standard Filter								
nach EN 60529 / UL 50	IP55*		-	NEMA Typ 12 - Faltenfilter							
Abscheidegrad	IP54	%	88					91			
	IP55*		-	91							
Güteklasse der Filtermatte	IP54		G 3					G 4			
nach EN 779	IP55*		-	G 4							
Einschaltdauer		%	100								
Lagerart			Gleitlager				Kugellager				
Lebensdauer L10 (+40°C) ¹		h	52500	37500		40000					
Temperaturbereich		°C (°F)	-40 ... +55°C (-40 ... +131°F)								
Bauweise (Gehäuse und Berührungsschutz)	IP54		aus thermoplastischem Kunststoff gespritzt, selbstverlöschend UL 94 VO								
	IP55*		-	zusätzlich: UV-beständig							
Farbe			RAL 7035 (Lichtgrau)								

Angabefelder mit zwei Werten (z.B.: 19 / 24) beziehen sich auf 50 / 60Hz

*Auf Anfrage erhältlich

¹Lüfterausfall wird definiert, wenn die Strom- und Drehzahlangaben abweichen oder das Betriebsgeräusch auffällig ist

Dimensions Filter Fans

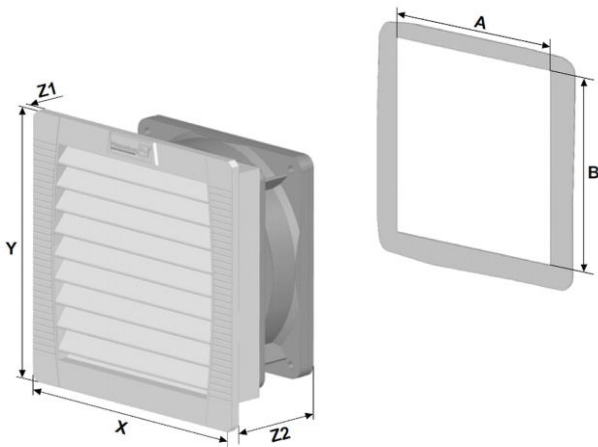

Tabel de date: Ventilator cu filtru IP54, 230VAC, 110mc/h, 202x202x87mm

Artikelnummer	X [mm]	Y [mm]	Z1 [mm]	Z2 [mm]	A* [mm]	B* [mm]
Filterventilatoren						
IUKNF1523A	109	109	4	62	92	92
IUKNF2523A	145	145	5	70	125	125
IUKNF3523A	202	202	6	87	177	177
IUKNF4523A	252	252	6	97	223	223
IUKNF5523A	252	252	6	113	223	223
IUKNF6523A	320	320	7	150	292	292
IUKNF7523A	320	320	7	150	292	292
IUKNF8523A	320	320	7	150	292	292
Austrittsfilter						
IUKNE150	109	109	4	19	92	92
IUKNE250	145	145	5	26	125	125
IUKNE350	202	202	6	34	177	177
IUKNE450	252	252	6	38	223	223
IUKNE550	320	320	7	39	292	292

* Für Materialdicke bis 2mm, +1mm für Materialdicke >2mm ≤3mm

IUKNF3523A Performance Curves: Cooling Capacity (left) and Static Pressure (right)

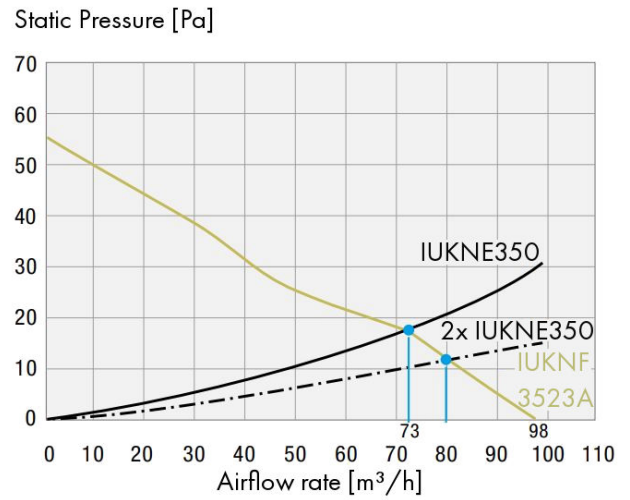
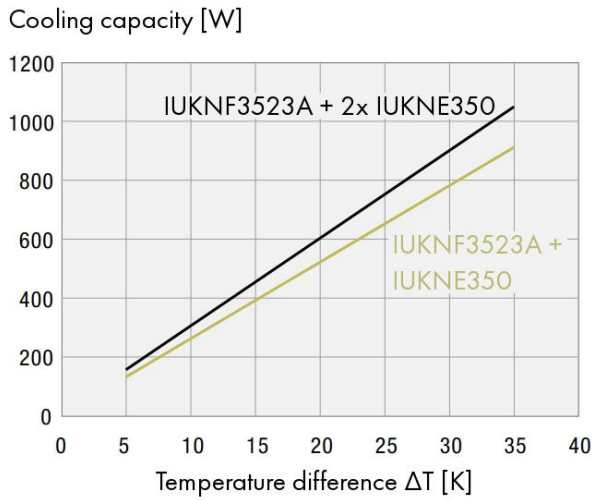

Tabel articole

Descriere	Cod comandă
Ventilator cu filtru IP54, 230VAC, 110mc/h, 202x202x87mm	IUKNF3523A
Accesorii necesare	
Filtru de ieșire 202x202x34mm, IP54	IUKNE350
Termostat pt. ventilarea dulapurilor, 1ND, comut. albastru	IUK08566
Accesorii opționale	
Filtru de rezervă pt. ventil. 202x202mm IP54 (1Set=5buc)	IUKM4710
Filtru de rezervă pt. ventil. 202x202mm IP55 (1Set=5buc)	IUKM4720