

Date tehnice pentru produs: DTWN095440

Dulap de perete DTW, 9U H=460 x W=540 x D=400, 19"

ATENȚIE !!! - expedierea acestor produse prin curier se face doar pe răspunderea clientului, există riscul deteriorării sale în timpul transportului.



SCHRACK-Info

Mainly used in offices and office-like environments, such as flats, single-family homes, etc. Suitable as a central distributor in small to medium-sized network installations, but also for use as a floor distributor (sub-distributor) in the horizontal area of structured cabling. For active cooling of the built-in components, optional DTLT fan units with one or two fans can be mounted in the roof.

- **Material:** Powder-coated steel sheet housing
- **Material thickness:**
 - Top and bottom chassis: 0.8mm
 - Rails: 1.5mm
 - Front door (glass): 4.0mm
 - Rear panel: 1.2mm
 - Side panel: 0.8mm
- **Colour:**
 - RAL7035 (light grey)
- **Heights:** 7, 9 and 12U
- **Maximum load:** with even distribution: 80kg
- **Degree of protection:** IP20
- **Doors:** Glass door of safety glass 4mm including lock and 2 keys. Door hinged on the right. Conversion to left-hinged possible. Opening angle of the door: approx. 200°.

- **Rails:** 19" rails (2 pieces) in the front of the cabinet, galvanised, depth-adjustable
- **Cable entry options:** in roof and floor
 - The floor is provided with a plastic blank cover.
 - The roof is equipped with a brush entry.
- **Cooling:**
 - Passive cooling through ventilation slots and heat exchange with the outside area.
 - Active cooling by optional DTLT fans
- **Accessories:** Numerous accessories available (shelves, PDUs, cable management, blank panels, fan units, etc.)
- **Delivery:** Enclosure is completely assembled. Mounting material optionally available (DTSRA0x0)



Fișe tehnice

Lățime netă (mm)	540,00
Înălțime (mm)	460,00
Adâncime netă (mm)	400,00
Masă netă (kg.)	11,20
COD EAN	9004840868944
Temperatura minimă a mediului ambiant (°C)	5
Temperatura maximă a mediului ambiant (°C)	40
UV	9
Culoare	Gri deschis
grad de protecție	IP20
Încărcare maximă (kg.)	80
Serie	S-RACK

Desen dimensional: Dulap de perete DTW, 9U H=460 x W=540 x D=400, 19"

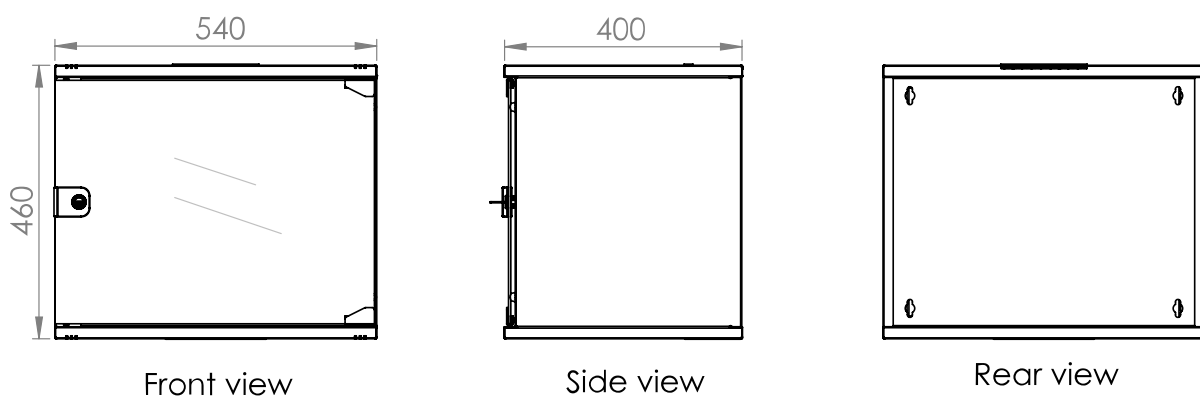

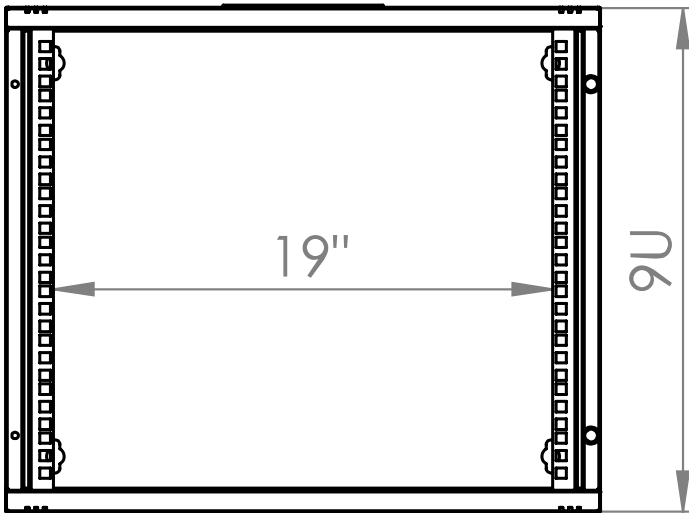
Desen dimensional: Dulap de perete DTW, 9U H=460 x W=540 x D=400, 19"

Front inside view

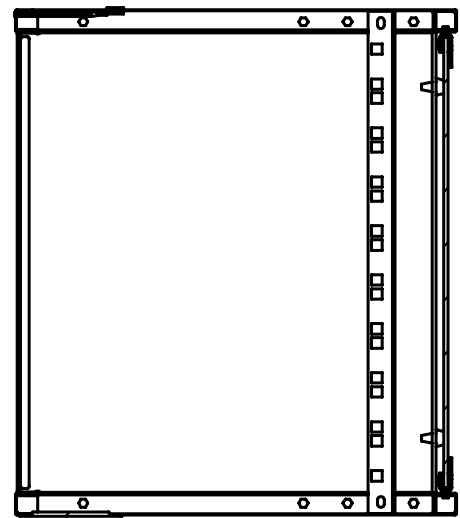

Side inside view

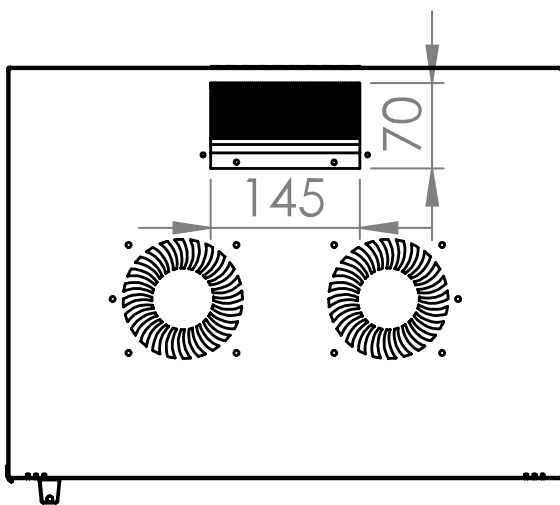
Desen dimensional: Dulap de perete DTW, 9U H=460 x W=540 x D=400, 19"

Top view

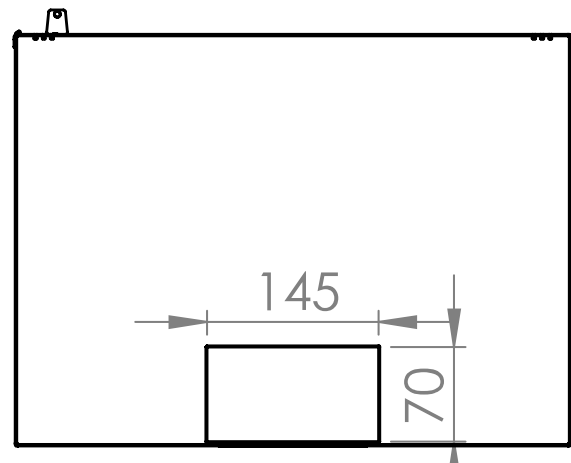

Bottom view

Desen dimensional: Dulap de perete DTW, 9U H=460 x W=540 x D=400, 19"

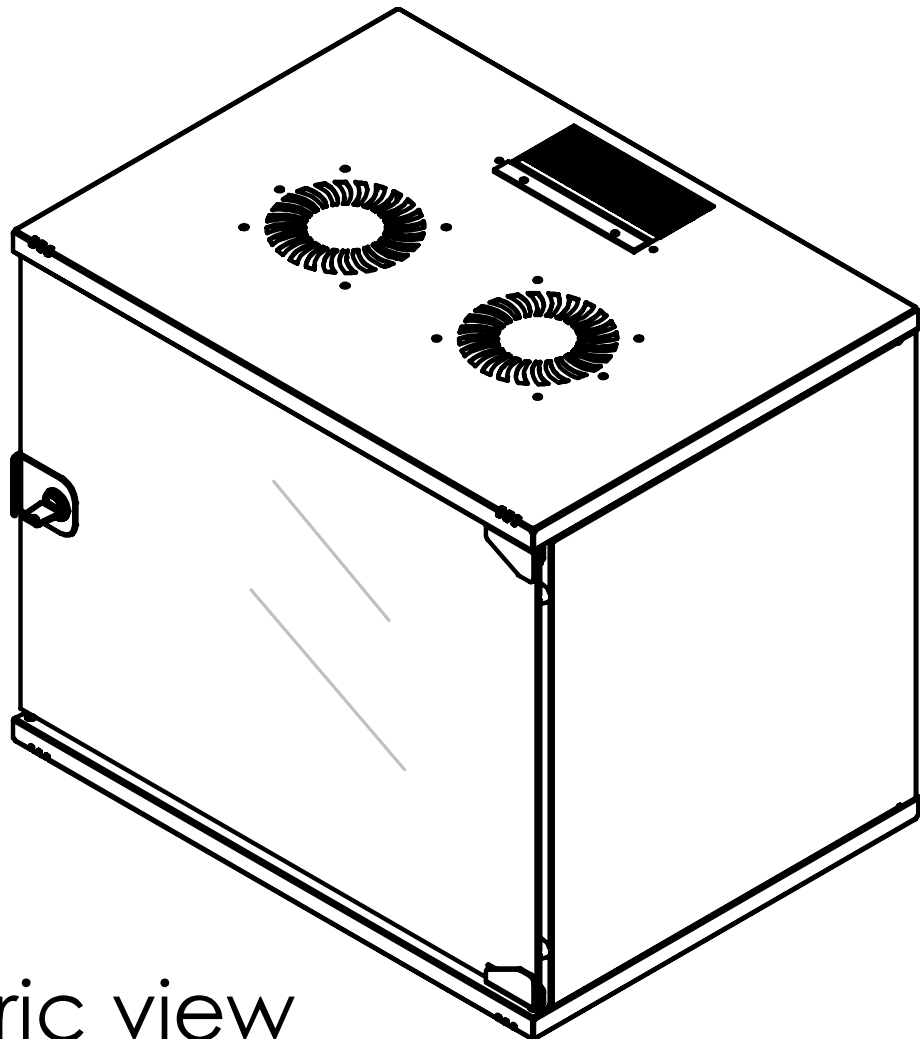

Isometric view

Desen dimensional: Dulap de perete DTW, 9U H=460 x W=540 x D=400, 19"

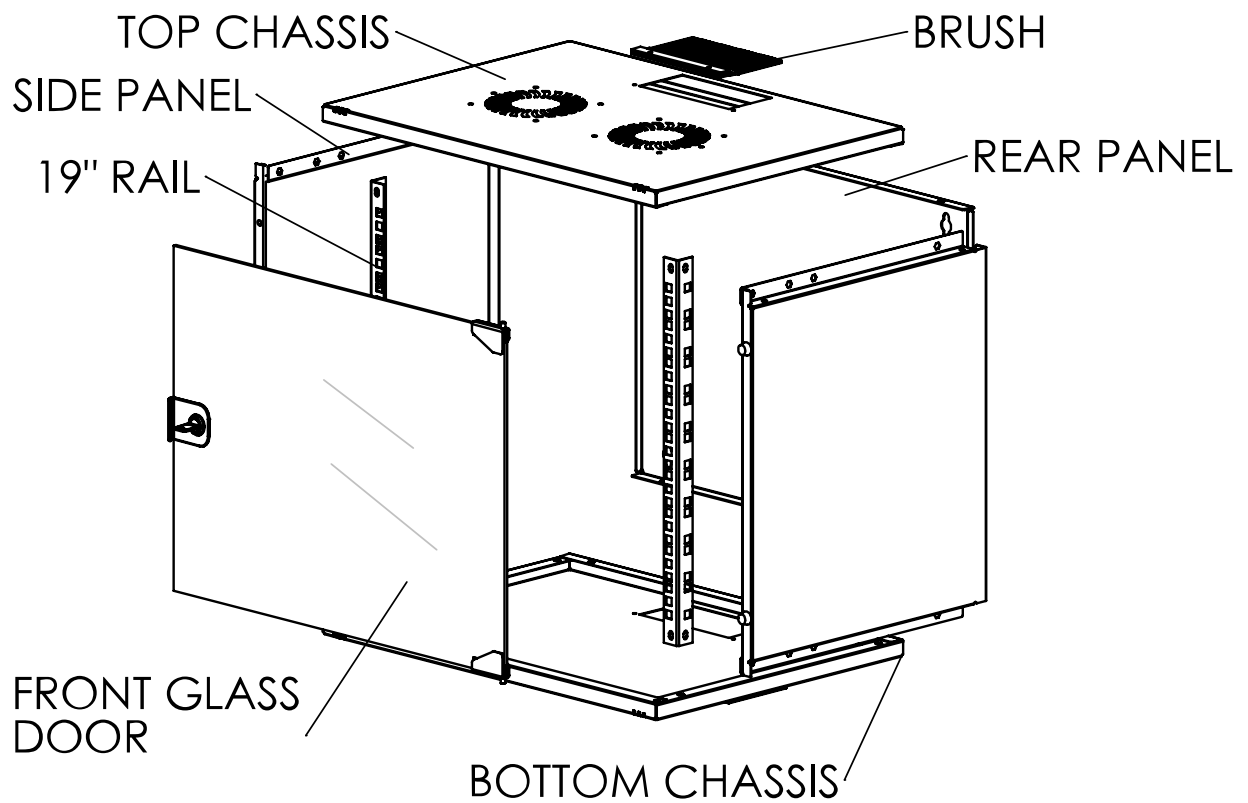

Exploded view

Tabel articole

Descriere	Cod comandă
Dulap de perete DTW, 9U H=460 x W=540 x D=400, 19"	
ATENȚIE !!! - expedierea acestor produse prin curier se face doar pe răspunderea clientului, există riscul deteriorării sale în timpul transportului.	DTWN095440
Accesorii opționale	
Unitate de tavan cu 2 ventilatoare, DT/DTW, termostat analog gri deschis, instalare din exterior	DTLTR02A
Unitate de tavan cu 2 ventilatoare, DT/DTW, comutator ON/OFF gri deschis, instalare din exterior	DTLTR02S
Unitate de tavan cu 1 ventilator, DT/DTW, termostat analogic gri deschis, instalare din exterior	DTLTR01A
Unitate de tavan cu 1 ventilator, DT/DTW, comutator ON/OFF gri deschis, instalare din exterior	DTLTR01S
Tavă fixă, 1U, sarcină 30 Kg, D=300mm, fixare în 2 puncte montaj 2 puncte	DTFT1300
Patchpanel pt. 24 module TOOLLESS LINE, 1UH, 19", RAL7035	HSER0240GS
Organizator 19" 1U, 5 inele metalice, RAL7035	DTBC105R
Set fixare profil 19" (20buc. Șurub+piuliță+șaiabă)	DTSRA020
Switch 24xRJ45 10/100/1000, silențios, f.vent., alim.intern Carcasă metalică, 19"	QLGSW2457
PDU 19", 9xSchuko, profil ALU 1U, cablu conexiune 2m, RAL7035	IU070114
PDU 19", 7xSchuko+prot suprat, prof PVC 1,25U, cabl 2m, RAL7035	IU070113
PDU 9x Schuko, 19", 1U, cablu 2m, comutator on/off negru, ALU ALU Profil	Q7070114-A
PDU 19", 7xSchuko, Comutator, protecție supratensiune, 1U cablu 2m, negru	Q7070113-A