

Date tehnice pentru produs: DT226010--

Dulap cablare structurată DT, 22U H1121 x W600 x D1000, 19"

ATENȚIE !!! - expedierea acestor produse prin curier se face doar pe răspunderea clientului, există riscul deteriorării sale în timpul transportului.



SCHRACK-Info

The S-RACK 19" freestanding network enclosure is the perfect solution for offices and similar environments. It is suitable for use as a central enclosure in network installations, but also as a sub-enclosure in the horizontal area of a structured cabling system.

The removable side and rear panels allow comfortable and easy access from all sides.

Cooling of the built-in components is achieved passively by heat exchange with the outside area and actively by optional roof fans.

Cable entry is very flexible due to various prepared opening possibilities or the optional base.

The S-RACK enclosures are designed for universal use and cover the widest possible range of applications.

- **Material thickness:**

- Top and bottom chassis: 1.5mm
- Corner profile: 1.2mm
- Rails: 1.5mm
- Front door (glass): 4.0mm
- Rear panel: 0.8mm
- Side panel: 0.8mm

- **Colour:**

- RAL7035 (light grey)
- Corner profile, top and bottom chassis: RAL5005 (signal blue)

- **Heights:** 16, 20, 22, 26, 32, 36, 42 and 47U

- **Widths:** 600 and 800mm
- **Depths:** 600, 800, 1.000 and 1.200mm
- **Maximum load:** with even distribution: 800kg
- **Degree of protection:** IP20
- **Dismountability:** The individual parts of the cabinet are screwed. The enclosure is delivered assembled and can be partially or completely disassembled for transport to places that are difficult to access.
- **Doors:** Glass door including comfort swing handle with lock and keys. A conversion kit for half cylinders (DTZLOCK02) is optionally available. External hinge system allows door opening angle of up to 180°. Door hinged on the right. Conversion to left hinged door is possible. Glass door can be replaced by optionally available doors DTRT (full metal or perforated, full width or double door).
- **Side and back panels:** Removable side and back panels with lock and keys. Rear wall can be replaced by optionally available doors DTRT (glass, full metal or perforated, full width or double door).
- **Cable entry options:** In roof and floor. Fitted with plastic blank covers. The floor also accommodates a large break-out blank plate which can be easily removed for cable entry. Brush entry DTBB optionally available.
- **Cooling:** Passive cooling through heat exchange with the outside area. Ventilation slots on the roof are prepared for cooling. Active cooling through optional DTLT fan units.
- **Rails:** 19" rails (4 pieces), depth adjustable, U markings included
- **Accessories:** Numerous accessories (base sets, fans, shelves, cable management, doors, etc.) available
- **Earthing:** Earthing set is included
- **Levelling Feet:** Levelling Feet are included
- **Included mounting material:** 16 pieces cage nuts, screws and washers
- **Delivery:** Enclosure is delivered fully assembled on a throw-away pallet.



Fișe tehnice

Lățime netă (mm)	600,00
Înălțime (mm)	1.121,00
Adâncime netă (mm)	1.000,00
Masă netă (kg.)	53,80
COD EAN	9004840868166
Temperatura minimă a mediului ambiant (°C)	5
Temperatura maximă a mediului ambiant (°C)	40
UV	22
Culoare	RAL 7035 / RAL 5005 (light grey / blue)
grad de protecție	IP20
Încărcare maximă (kg.)	800
Serie	S-RACK

Desen dimensional: Dulap cablare structurată DT, 22U H1121 x W600 x D1000, 19"

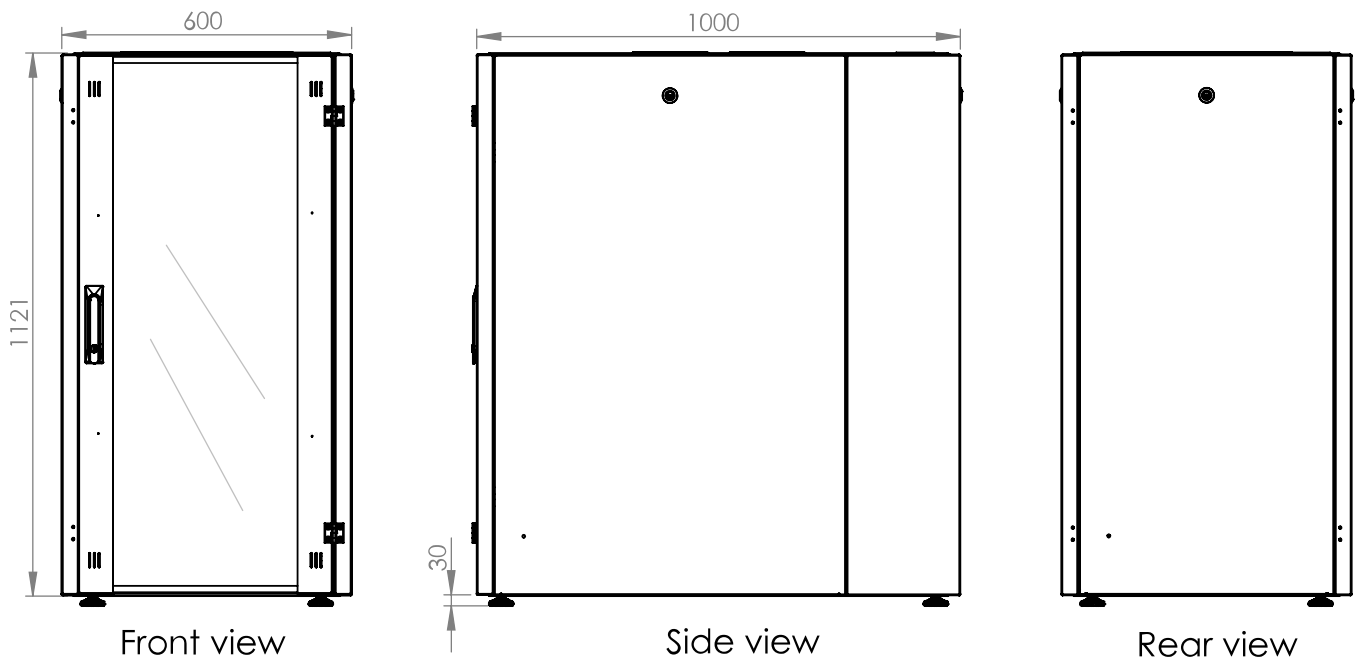

Desen dimensional: Dulap cablare structurată DT, 22U H1121 x W600 x D1000, 19"

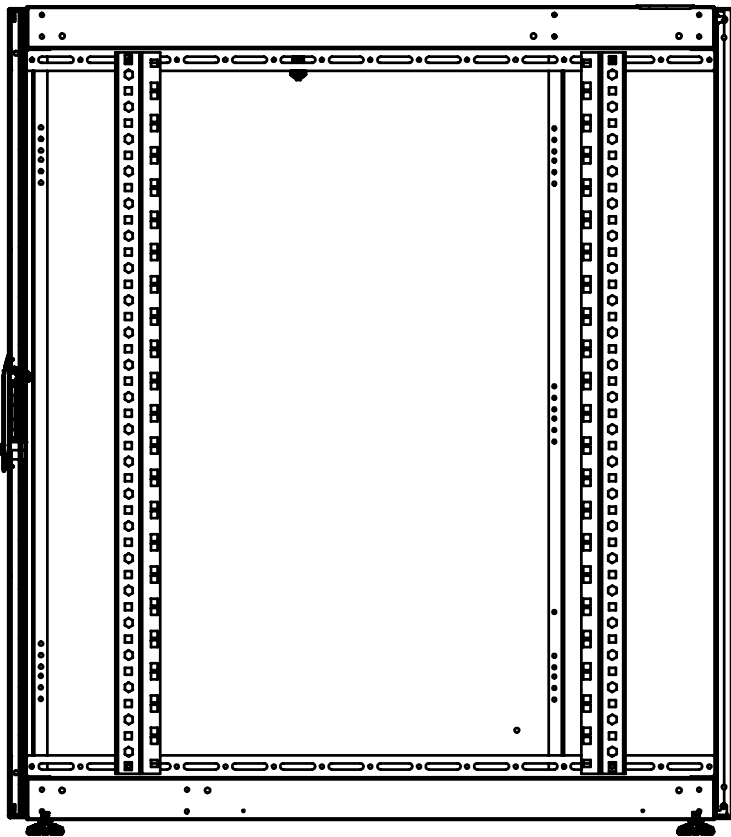

Side inside view

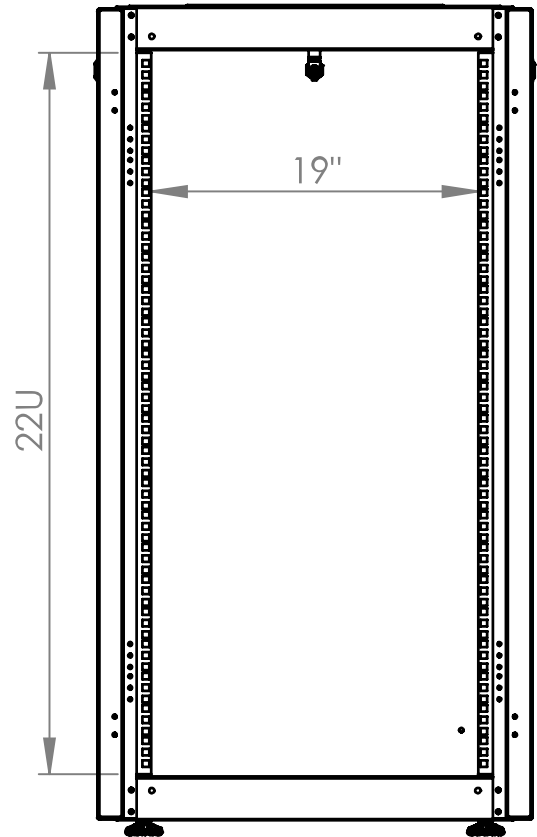

Front inside view

Desen dimensional: Dulap cablare structurată DT, 22U H1121 x W600 x D1000, 19"

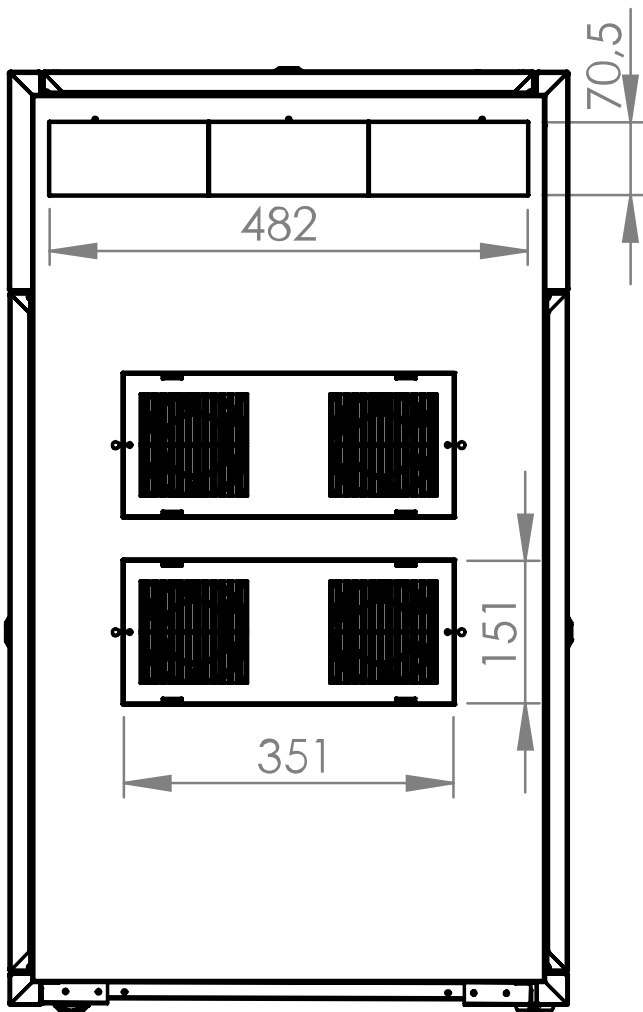

Top view

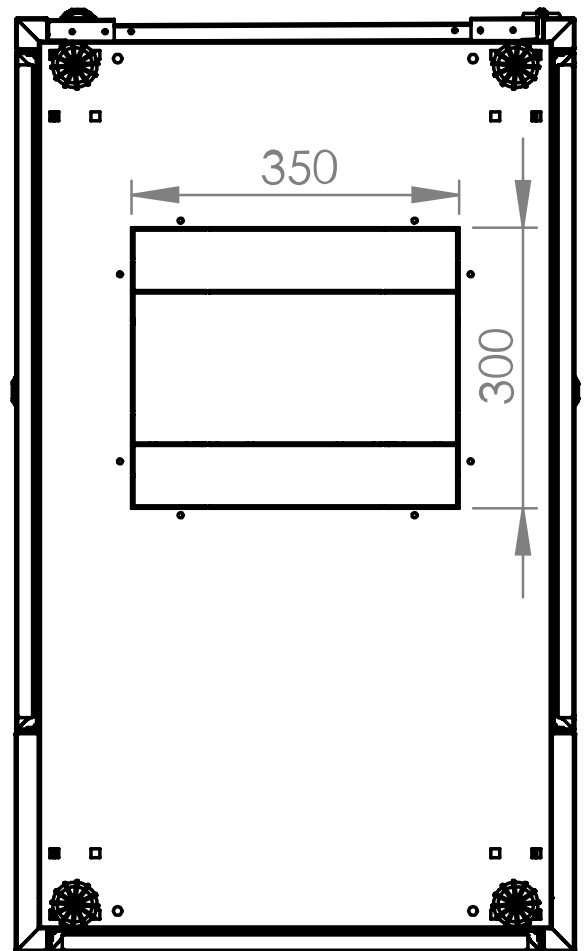

Bottom view

Desen dimensional: Dulap cablare structurată DT, 22U H1121 x W600 x D1000, 19"

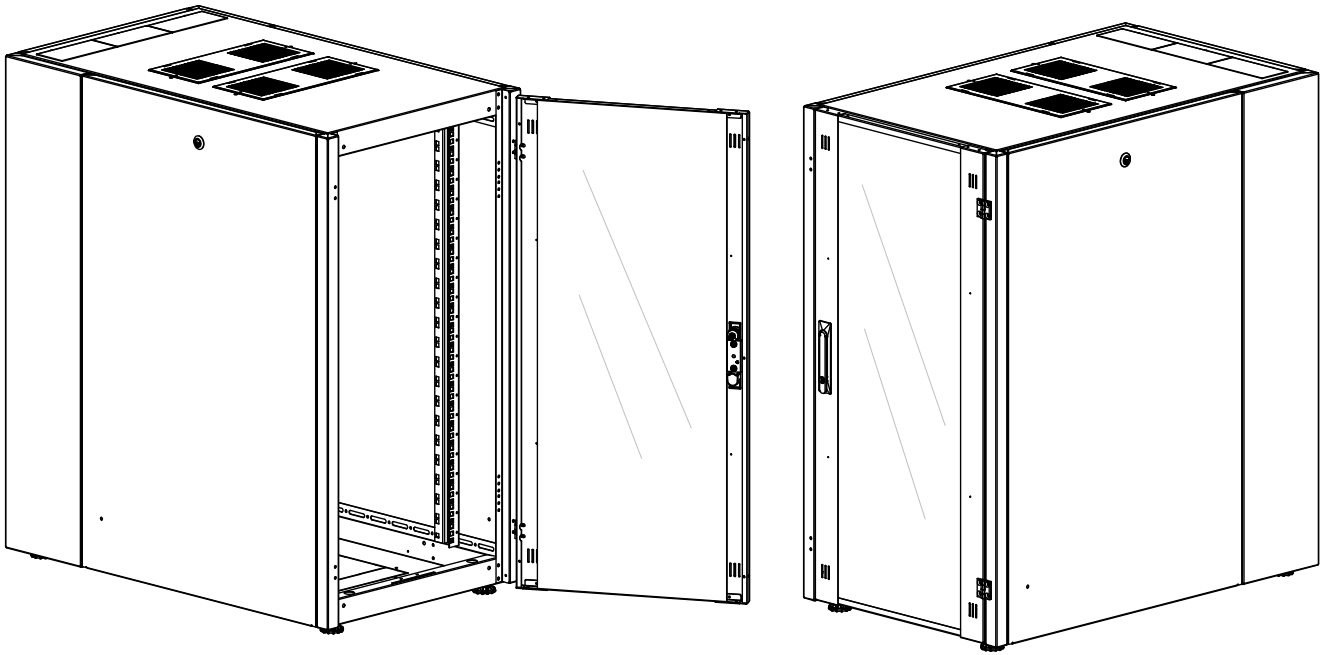

Desen dimensional: Dulap cablare structurată DT, 22U H1121 x W600 x D1000, 19"

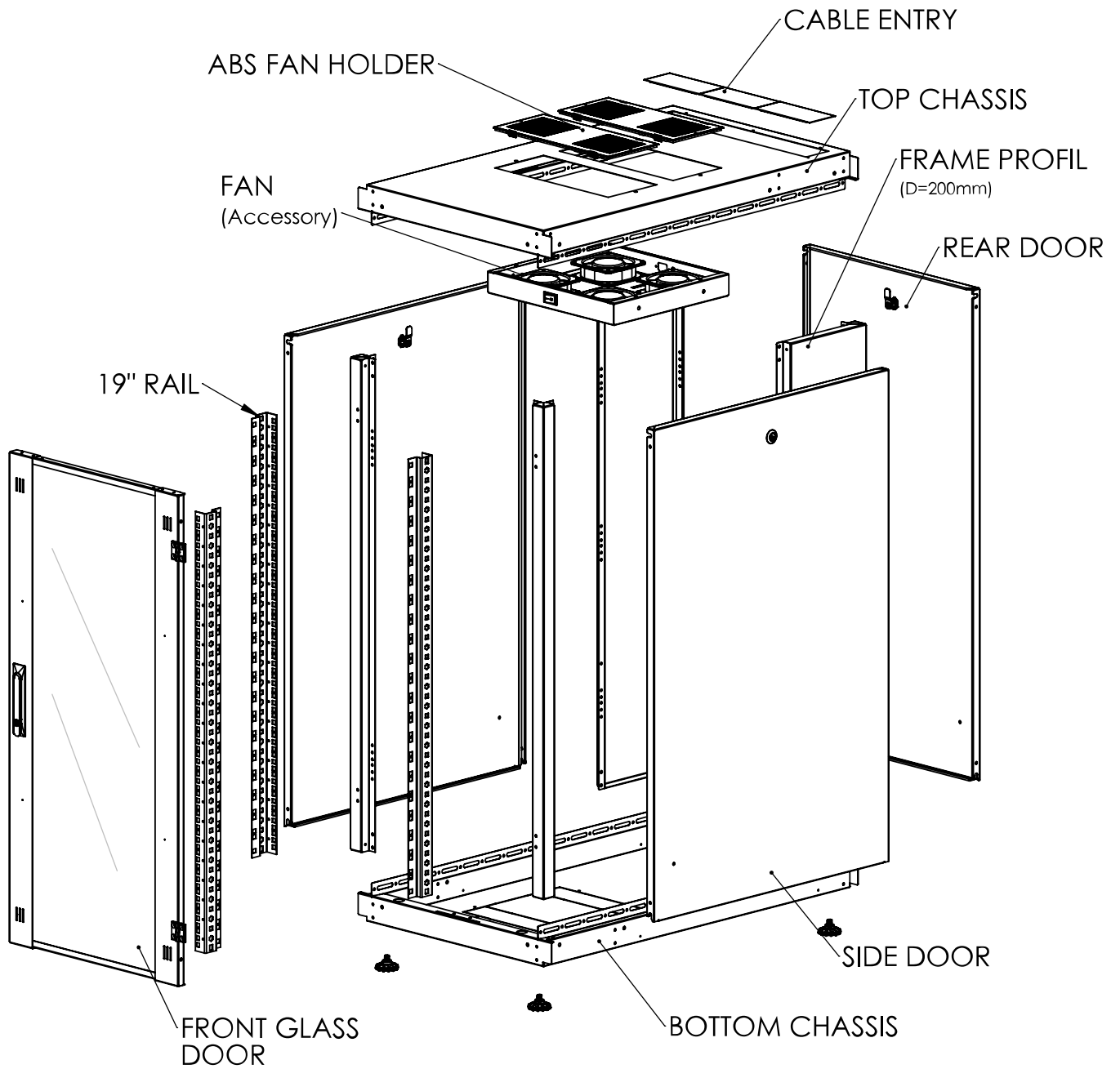

Exploded view

Tabel articole

Descriere	Cod comandă
Dulap cablare structurată DT, 22U H1121 x W600 x D1000, 19"	
ATENȚIE !!! - expedierea acestor produse prin curier se face doar pe răspunderea clientului, există riscul deteriorării sale în timpul transportului.	DT226010
Accesorii opționale	
Soclu pentru dulap DT, set H=100 W=600 x D=1000, RAL7035	DTOT106010
Unitate de tavan cu 2 ventilatoare, DT/DTW, termostat analog gri deschis, instalare din exterior	DTLTR02A
Unitate de tavan cu 4 ventilatoare, DT, termostat digital gri deschis, instalare din interior	DTLTR04D
Unitate de tavan cu 4 ventilatoare, DT, termostat analogic gri deschis, instalare din interior	DTLTR04A
Perie pentru tavan și podea pentru dulapuri DT, 70x316mm 70x316mm, înlocuiește 2 panouri oarbe	DTZBRUSH02
Perie pentru tavan și podea pentru dulapuri DT, 70x500mm 70x500mm, înlocuiește 3 panouri oarbe	DTZBRUSH03
Măner rotativ pentru kit conversie la jumătate cilindru DT freestanding enclosure DT and wallmounting enclosure DTWI. For DTWI additionally necessary is DTZLOCK05	DTZLOCK02
Kit imbinare DT A=800, 1000mm albastru RAL 5005 1 Set = 2 capace (pentru partea superioară și jos) + 8x șuruburi 6,3 x 12	DTRA0800
Tavă fixă 19", 1U, 50kg sarcină, D=720, fixare 4 puncte montaj 4 puncte	DTFF1720
Tavă fixă, 2U, sarcină 50 Kg, D=650mm, fixare în 4 puncte montaj 4 puncte	DTFL2650
Organizator 19" 1U, 5 inele metalice, RAL7035	DTBC105R
Set fixare profil 19" (50buc. Șurub+piuliță+șaiabă)	DTSRA050
Lampă LED, magnet, 230VAC, cu senzor deschidere ușă aprindere automată cand ușa este deschisă	DTLIGHT01
Set împământare 19", 1U , 10 puncte de împământare 4 buc x 4mm diametru x fir 40 cm lung verde/galben, inclusiv șuruburi și piulițe	DTRE0001
Patchpanel pt. 24 module TOOLLESS LINE, 1UH, 19", RAL7035	HSER0240GS
PDU 9xSchuko, 19", Profil ALU 1U, cablu 3m, RAL7035	IU070114-3
PDU 19", 7xSchuko+prot suprat, prof PVC 1,25U, cabl 2m, RAL7035	IU070113
PDU 9x Schuko, 19", 1U, cablu 2m, comutator on/off negru, ALU ALU Profil	Q7070114-A
PDU 19", 7xSchuko, Comutator, protecție supratensiune, 1U cablu 2m, negru	Q7070113-A
Switch 24xRJ45 10/100/1000, silențios, f.vent., alim.intern Carcasă metalică, 19"	QLGSW2457