

CEM18.01-48V-50/60Hz



Specificatii

Cod ETI	004644111
Descriere	CEM18.01-48V-50/60Hz
Denumire clasă	Contactorul motorului
Func ie	Contactor pentru motoare
I (AC1) (A)	32
I (AC3 400V) (A)	18
P (AC3 kW) (kW)	7,5
Număr de contacte auxiliare NC	1
Număr de poli	3
Număr de contacte auxiliare NO	0
Tensiunea nominala (V AC)	690
Tensiunea de control Uc (V AC)	48

Pagina de produse online

Alta documentatie



Catalog caracteristici tehnice

Model 3D

Manual de instructiuni

Declaratie CE

Eplan mușchi

ETIM clasificare internationala

Clasificare	EC000066
Denumire clasă	Power contactor, AC switching
Rated control supply voltage AC 50 Hz	48...48V
Rated control supply voltage AC 60 Hz	48...48V
Rated control supply voltage DC	48...48V
Voltage type for actuating	AC
Rated operation current I _e at AC-1, 400 V	32A
Rated operation current I _e at AC-3, 400 V	18A
Rated operation power at AC-3, 400 V	7,5kW
Modular version	
Number of auxiliary contacts as normally closed contact	1
Type of electrical connection of main circuit	Frame clamp
Number of normally open contacts as main contact	3

Desen cotat

	AC	DC
CAEM4	A=85	A=115
CEM9	A=85	A=115
CEM12	A=85	A=115
CEM18	A=85	A=115
CEM25	A=87	A=117

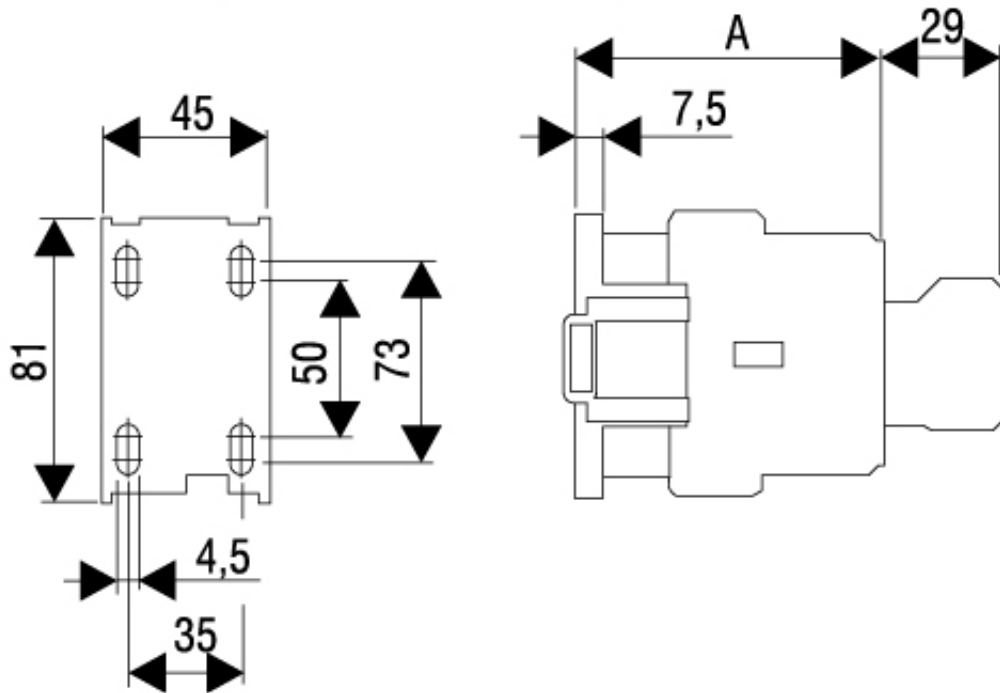

Schema de conexiuni

