

# CEM12.01-24V-DC



## Specificatii

Cod ETI	004643210
Descriere	CEM12.01-24V-DC
Denumire clasă	Contactorul motorului
Func ie	Contactor pentru motoare
I (AC1) (A)	25
I (AC3 400V) (A)	12
P (AC3 kW) (kW)	5,5
Număr de contacte auxiliare NC	1
Număr de poli	3
Număr de contacte auxiliare NO	0
Tensiunea nominala (V AC)	690
Tensiunea de control Uc (V DC)	24

Pagina de produse online

## Alta documentatie



Catalog caracteristici tehnice

Model 3D

Manual de instructiuni

Declaratie CE

Eplan mușchi

## ETIM clasificare internationala

Clasificare	EC000066
Denumire clasă	Power contactor, AC switching
Rated control supply voltage DC	24...24V
Voltage type for actuating	DC
Rated operation current I <sub>e</sub> at AC-1, 400 V	25A
Rated operation current I <sub>e</sub> at AC-3, 400 V	12A
Rated operation power at AC-3, 400 V	5,5kW
Modular version	
Number of auxiliary contacts as normally closed contact	1
Type of electrical connection of main circuit	Frame clamp
Number of normally open contacts as main contact	3

## Desen cotat

	AC	DC
CAEM4	A=85	A=115
CEM9	A=85	A=115
CEM12	A=85	A=115
CEM18	A=85	A=115
CEM25	A=87	A=117

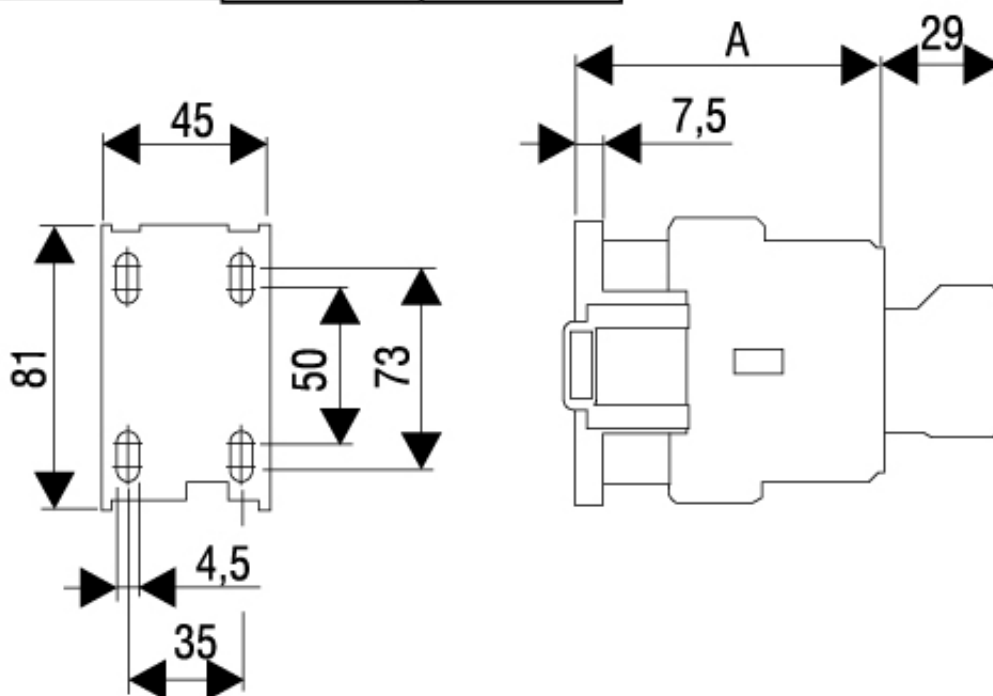

## Schema de conexiuni

