

NH0 gPV 100A/1000V DC



Specificatii

Cod ETI	004110387
Descriere	NH0 gPV 100A/1000V DC
Denumire clasă	Siguranță
Curent nominal (A)	100
Tip	NH
Mărime	NH0
Caracteristici	gPV
Tensiune nominală DC (V)	1000
Indicator	Indicator principal al siguranței
Capacitatea de rupere DC (kA)	20
Putere disipată (W)	21
Standarde	IEC 60269-6
Operare Joule integrală (A2s)	5.280
L/R (ms)	2
Curentul de pre-arc (A2s)	1.110
Aplicație	Sigurante fuzibile pentru aplicații DC
efuse	1

[Pagina de produse online](#)

Alta documentatie



[Catalog caracteristici tehnice](#)

[Model 3D](#)

[Declaratie CE](#)

[Eplan mușchi](#)

ETIM clasificare internationala

Clasificare	EC000055
Denumire clasă	Low Voltage HRC fuse
Construction size	NH0
Rated current	100
Rated voltage	1000
Voltage type	DC
Rated switching capacity	20
Utilization category	gPV (photovoltaic protection)
Type of fuse status indicator	Top fuse status indicator
Insulated metal gripping lugs (IMGL)	

Desen cotat

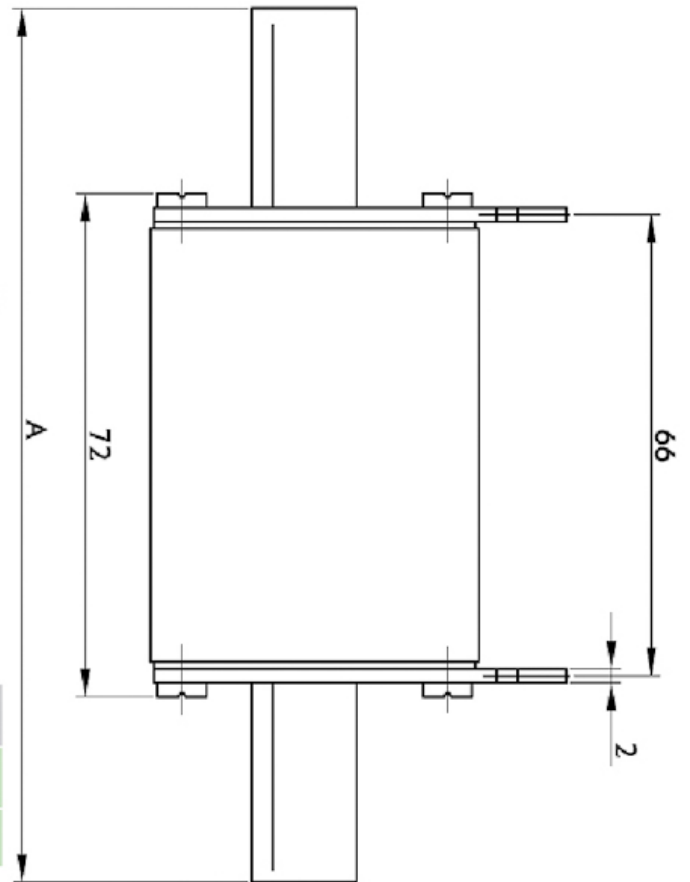
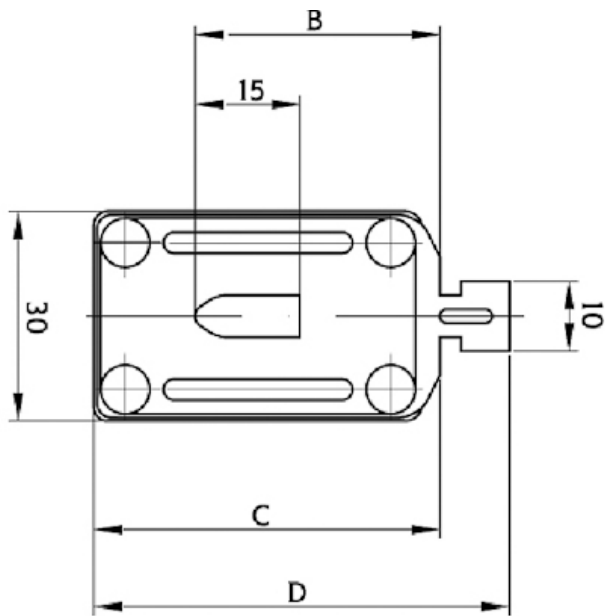

Size	A	B	C	D
0	125	35	50	60
1C	135	40	55	65