

*EFD 10 3p+N NEON



Specificatii

Cod ETI	002540025
Descriere	*EFD 10 3p+N NEON
Denumire clasă	Siguranță
Curent nominal (A)	32
Tip montaj	TH 35
Mărime	10x38
Număr de poli	3+N
Tensiune nominală AC (V)	690
Categorie de utilizare	AC-22B
Conectare	1 - 25mm ²

[Pagina de produse online](#) 

Alta documentatie



[Catalog caracteristici tehnice](#)

[Model 3D](#)

[Declaratie CE](#)

[Eplan mușchi](#)

ETIM clasificare internationala

Clasificare	EC002705
Denumire clasă	Holder for cylindrical fuse
Mounting method	Other
For fuse size	10x38 mm
Number of poles	4

Desen cotat

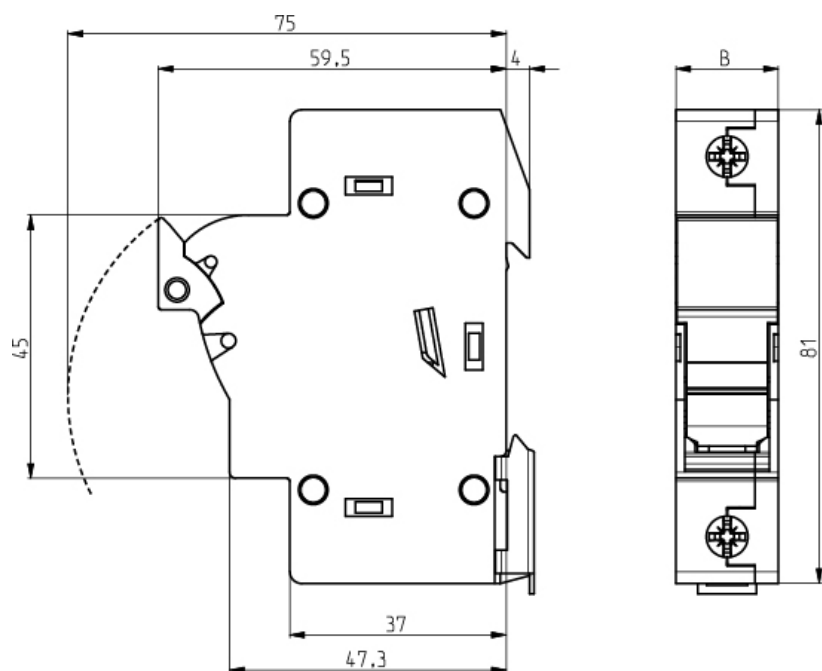

	B
EFD 8, 10 1p	17,5
EFD 8, 10 1p+N	35
EFD 8, 10 2p	35
EFD 8, 10 3p	52,5
EFD 8, 10 3p+N	70