

PRI-51/5



Specificatii

Cod ETI	002471818
Descriere	PRI-51/5
Denumire clasă	Releu control
Func ie	Relee monitorizare și control
Curent nominal (A)	8
AC Tensiunea bobinei Uc (V)	24...24
Număr contacte CO	1
DC tensiunea nominală a bobinei Uc (V)	24
Tipul voltajului	AC/DC
Tensiunea de alimentare (V)	24-240
Numarul de contacte	1
Capacitatea maxima de incarcare AC1 (VA)	2500

Pagina de produse online [🔗](#)

Alta documentatie



Catalog caracteristici tehnice

Model 3D

Manual de instructiuni

Declaratie CE

Eplan mușchi

ETIM clasificare internationala

Clasificare	EC001440
Denumire clasă	Current monitoring relay
Type of electric connection	Clip connection
Single-phase under current possible	1
Single-phase overcurrent possible	1
Rated control supply voltage AC 50 Hz	24...240V
Voltage type for actuating	AC/DC
Current measuring range	0.5...5A
Number of contacts as change-over contact	1
Width	18mm
Height	90mm
Depth	65mm

Simbol/Conexiune

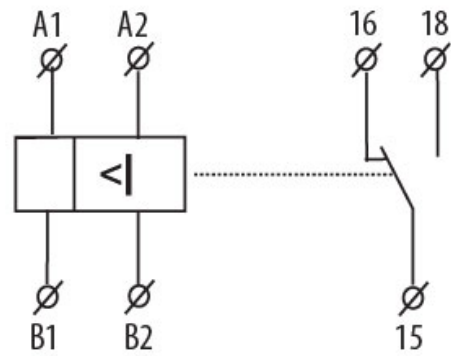
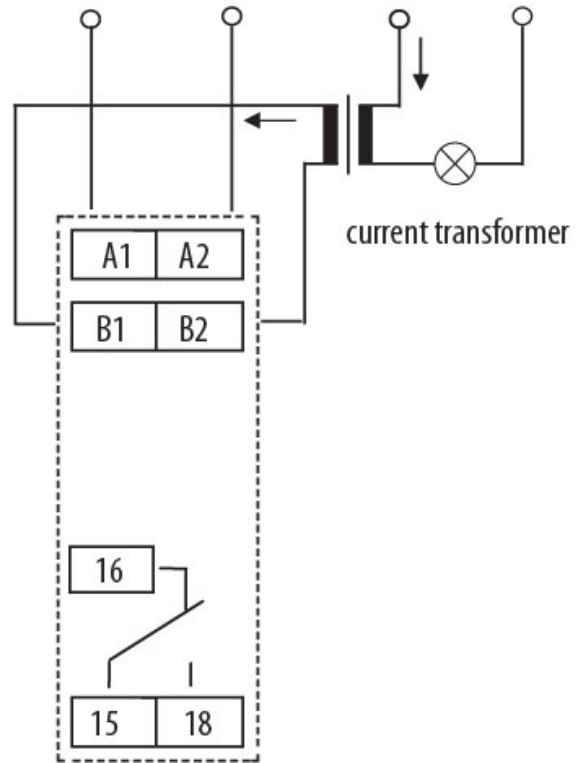
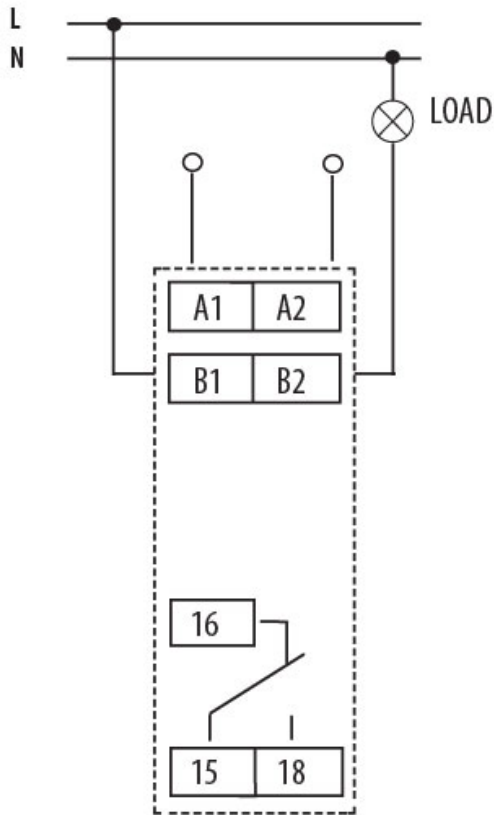

Descriere

