

MOD.ETITEC D T3 440/3



Specificatii

Cod ETI	002440422
Descriere	MOD.ETITEC D T3 440/3
Denumire clasă	Protec ie supratensiuni
Func ie	Modul SPD
Tip	T3
Utilizare cu	ETITEC D T3

[Pagina de produse online](#) 

Alta documentatie



[Catalog caracteristici tehnice](#)

[Model 3D](#)

[Manual de instructiuni](#)

[Eplan mușchi](#)

ETIM clasificare internationala

Clasificare	EC000942
Denumire clasă	Surge protection device for terminal equipment
Mounting method	On basic element
Nominal voltage AC	400
Max. continuous voltage AC	440
Nominal discharge surge current (8/20) (L-N)	3
Category type 3	1
With interference suppressor filter	
Degree of protection (IP)	IP20

Desen cotat

ETITEC D T3 275/3 1+0 RC

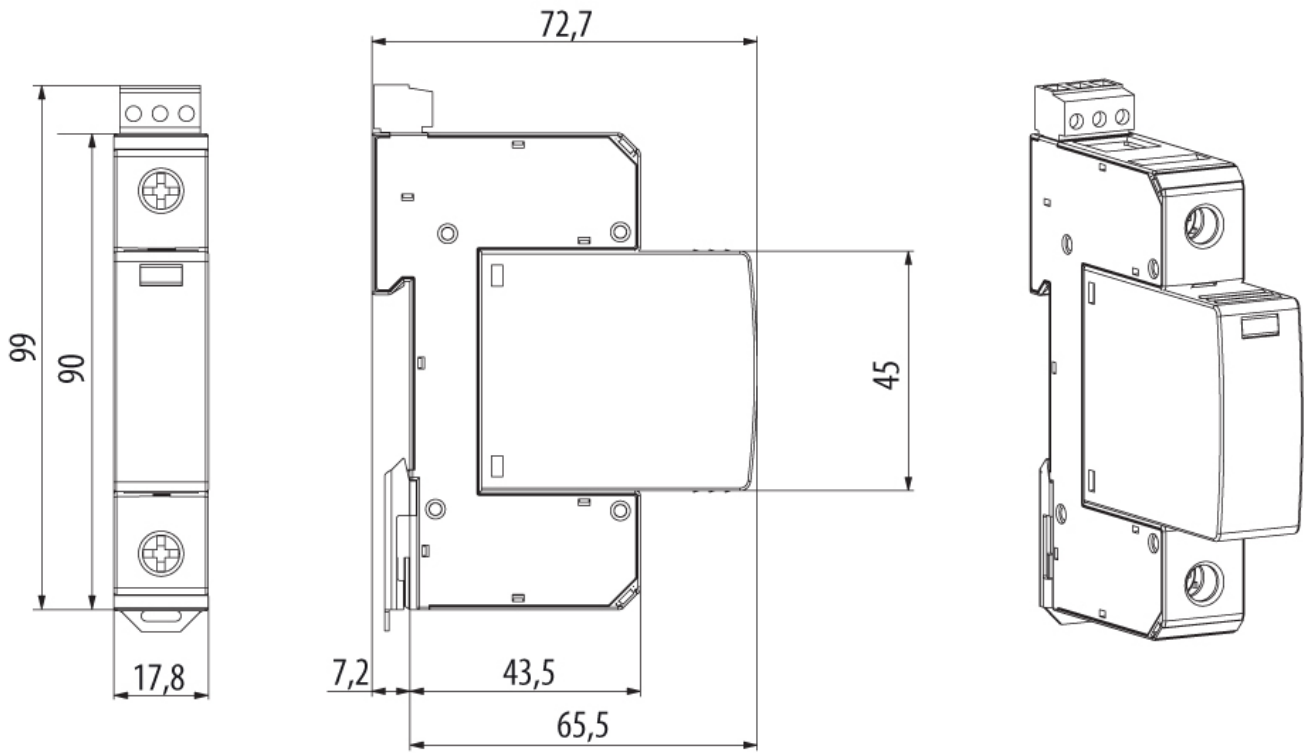

Simbol/Conexiune

