

MOD. ETITEC C T2 275/20



Specificatii

Cod ETI	002440414
Descriere	MOD. ETITEC C T2 275/20
Denumire clasă	Protec ie supratensiuni
Func ie	Modul SPD
Tip	T2
Utilizare cu	ETITEC C T2

[Pagina de produse online](#)

Alta documentatie



[Catalog caracteristici tehnice](#)

[Model 3D](#)

[Manual de instructiuni](#)

[Declaratie CE](#)

[Eplan mușchi](#)

ETIM clasificare internațională

Clasificare	EC000941
Denumire clasă	Surge protection device for power supply systems
System configuration DC	
System configuration IT	
System configuration TN	1
System configuration TN-C	1
System configuration TN-S	1
System configuration TT	1
System configuration other	
Nominal discharge surge current (8/20)	20
Nominal voltage AC	230
Max. continuous voltage AC	275
Max. discharge surge current (8/20)	40
Mounting method	On basic element
Construction size	1 modular spacing
Integrated backup fuse	
Signalling at the device	Optical
Category type 2	1
Degree of protection (IP)	IP20

Desen cotat

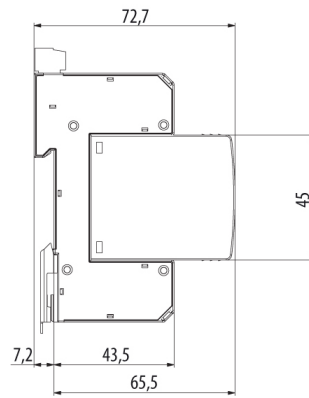
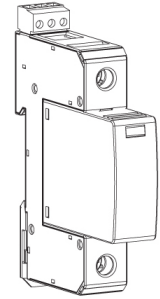
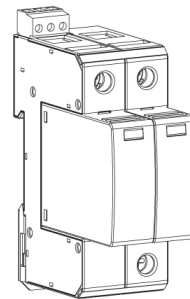
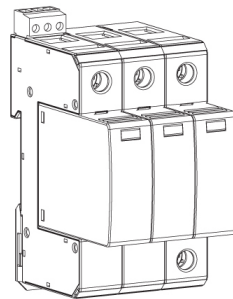
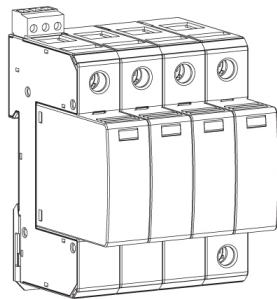
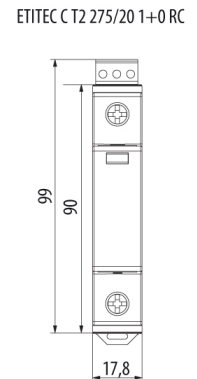
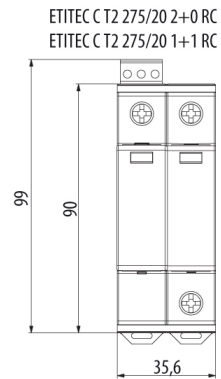
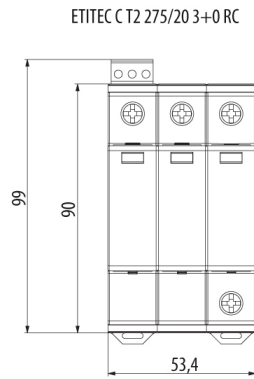
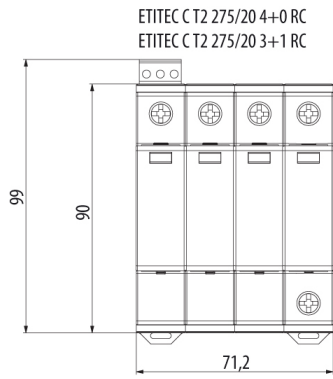

Simbol/Conexiune

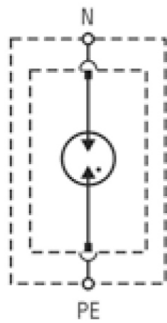

ETITEC CT2 G

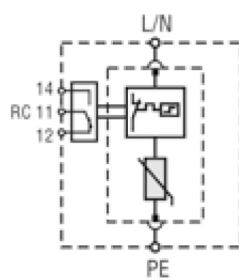

ETITEC CT2 1+0 RC

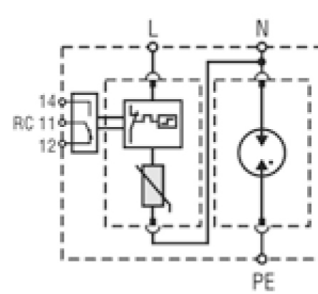

ETITEC CT2 1+1 RC

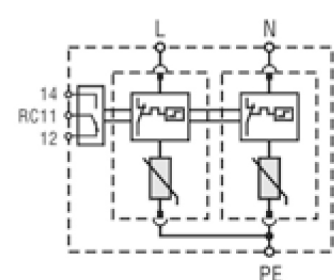

ETITEC CT2 2+0 RC

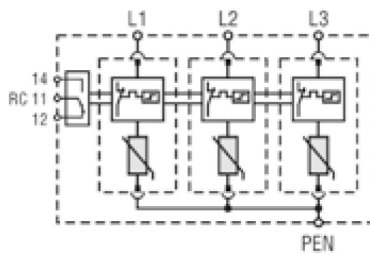

ETITEC CT2 3+0 RC

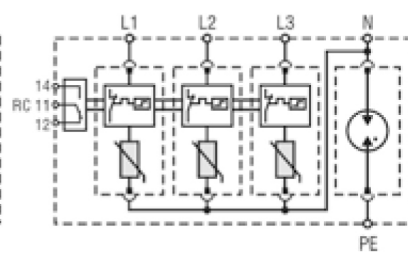

ETITEC CT2 3+1 RC

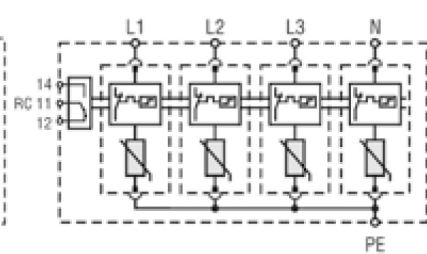

ETITEC CT2 4+0 RC