

VL D01 10A 3p+N



Specificatii

Cod ETI	002261022
Descriere	VL D01 10A 3p+N
Denumire clasă	Comutator cu siguranță
Curent nominal (A)	10
Tip montaj	TH 35
Mărime	D01
Număr de poli	3+N
Grup de produse	separator siguranță-JT
Tensiune nominală AC (V)	400
Categorie de utilizare	AC-22A

[Pagina de produse online](#) 

Alta documentatie



[Catalog caracteristici tehnice](#)

[CertIFICATE](#)

[Model 3D](#)

[Manual de instructiuni](#)

[Declaratie CE](#)

[Eplan mușchi](#)

ETIM clasificare internationala

Clasificare	EC000277
Denumire clasă	D0-system switch disconnector
Number of poles	4
Construction size	D01
Rated voltage	400V
Rated current	10A

Desen cotat

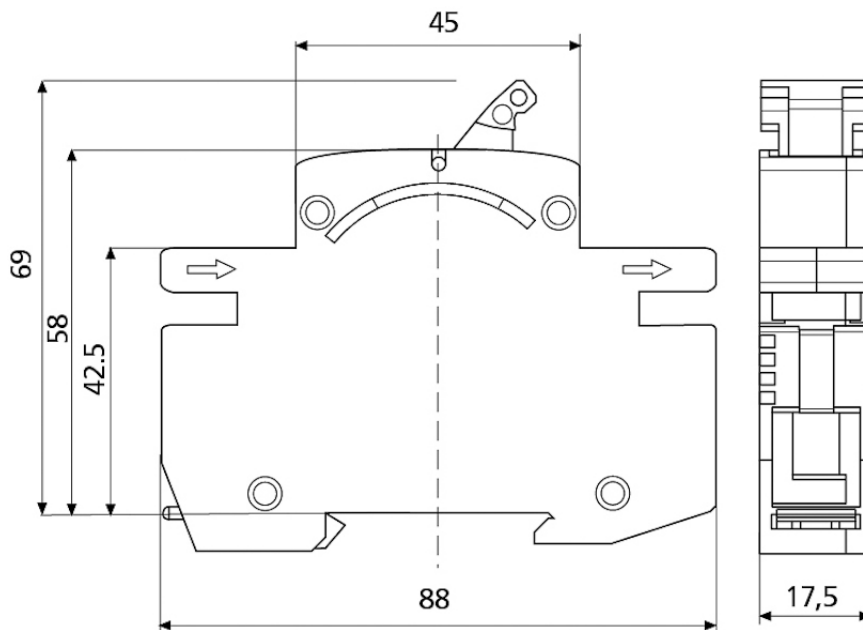

	B [mm]
1p	17,5
1p+N	35
2p	35
3p	52,5
3p+N	70