

KZS-2M2p A C6/0.03



Specificatii

Cod ETI	002172521
Descriere	KZS-2M2p A C6/0.03
Denumire clasă	Diferențial RCBO
Capacitatea de rupere (kA)	10
Caracteristică de întrerupere	C
Curent nominal (A)	6
Tip	A
Curent de defect nominal (A)	0.03
Tip curent	A
Tensiunea nominală(V)	230
Număr de poli	2
Frecvență nominală (Hz)	50/60 Hz
Standarde	IEC/EN 61009
Secțiune transversală nominală	1-25

[Pagina de produse online](#) 

Alta documentatie



[Catalog caracteristici tehnice](#)

[Certificate](#)

[Model 3D](#)

[Manual de instructiuni](#)

[Declaratie CE](#)

[Eplan mușchi](#)

ETIM clasificare internationala

Clasificare	EC000905
Denumire clasă	Earth leakage circuit breaker
Number of poles (total)	2
Number of protected poles	2
Rated voltage	230V
Rated current	6A
Rated fault current	0,03A
Leakage current type	A
Current limiting class	3
Rated short-circuit breaking capacity according to EN 61009	10kA
Frequency	50/60 Hz
Release characteristic	C
Concurrently switching neutral conductor	1
Width in number of modular spacings	2
Built-in depth	69mm
Degree of protection (IP)	IP20
Connectable conductor cross section multi-wired	1...25mm ²

Desen cotat

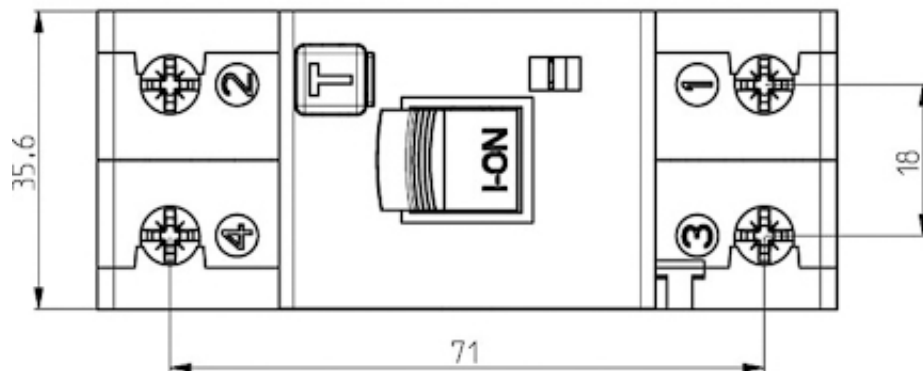
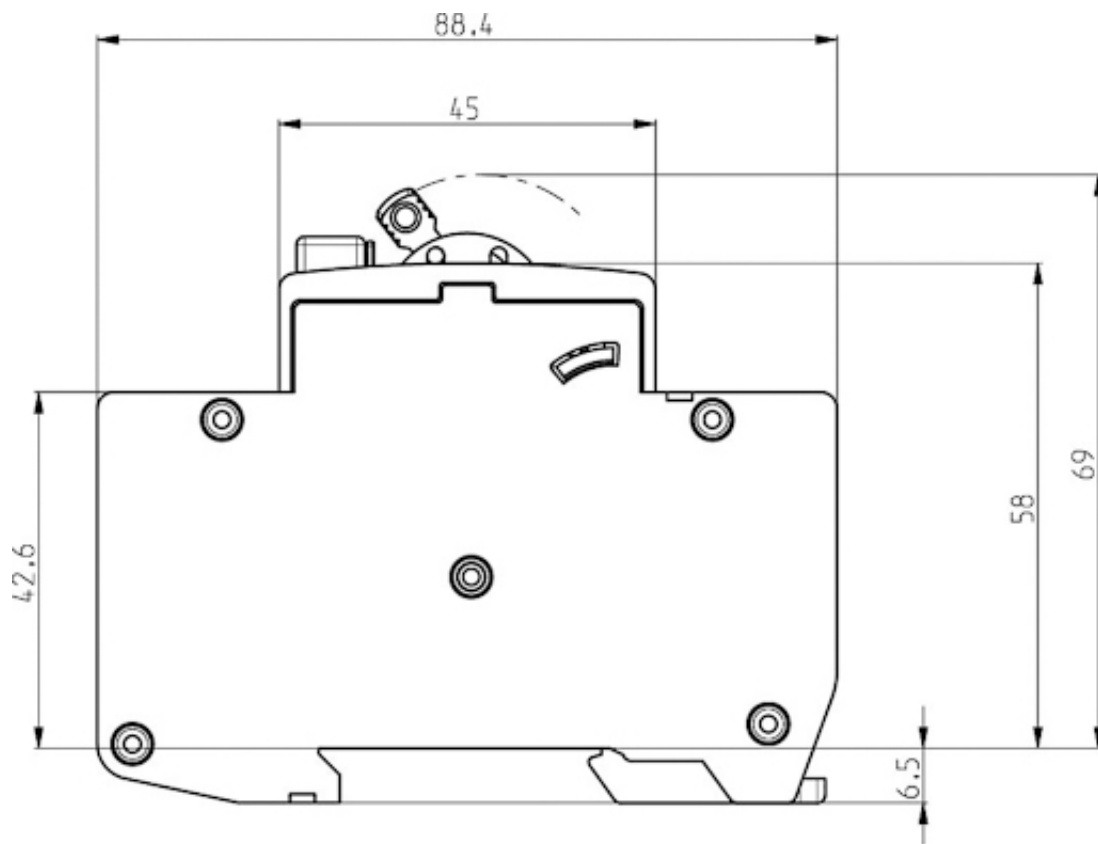

Simbol/Conexiune

