

KZS-2M2p EDI A C20/0.03



Specificatii

Cod ETI	002172417
Descriere	KZS-2M2p EDI A C20/0.03
Denumire clasă	Diferențial RCBO
Capacitatea de rupere (kA)	10
Caracteristică de întrerupere	C
Curent nominal (A)	20
Tip	A
Curent de defect nominal (A)	0.03
Tip curent	A
Tensiunea nominală(V)	230
Număr de poli	2
Frecvență nominală (Hz)	50/60 Hz
Standarde	IEC 61009
Seciune transversală nominală	1-25

[Pagina de produse online](#)

Alta documentatie



[Catalog caracteristici tehnice](#)

[Model 3D](#)

[Manual de instructiuni](#)

[Declaratie CE](#)

[Eplan mușchi](#)

ETIM clasificare internațională

Clasificare	EC000905
Denumire clasă	Earth leakage circuit breaker
Number of poles (total)	2
Number of protected poles	2
Rated voltage	230V
Rated current	20A
Rated fault current	0,03A
Leakage current type	A
Current limiting class	3
Rated short-circuit breaking capacity according to EN 61009	10kA
Voltage type	AC
Frequency	50 Hz
Release characteristic	C
Concurrently switching neutral conductor	1
Over voltage category	3
Ambient temperature during operating	-25...40°C
Width in number of modular spacings	2
Built-in depth	69mm
Degree of protection (IP)	IP20
Connectable conductor cross section solid-core	1...25mm ²
Connectable conductor cross section multi-wired	1...25mm ²

Desen cotat

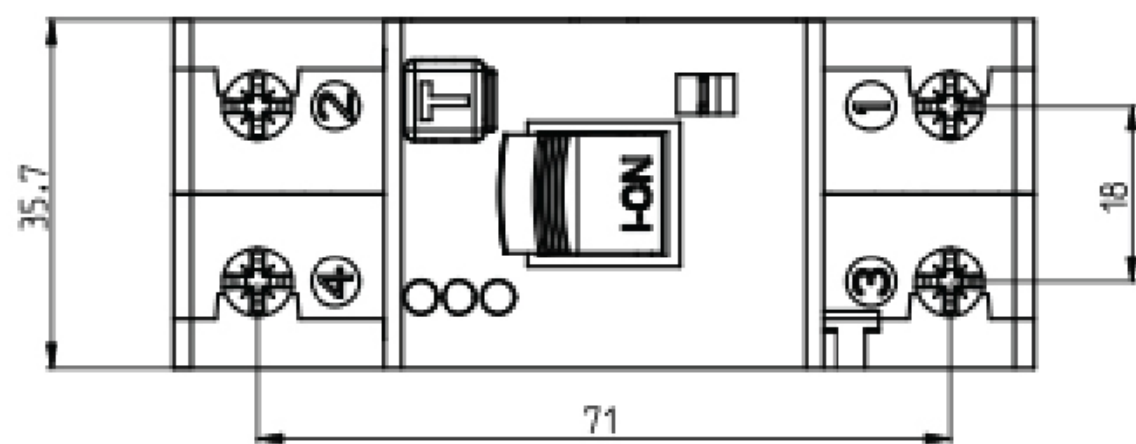
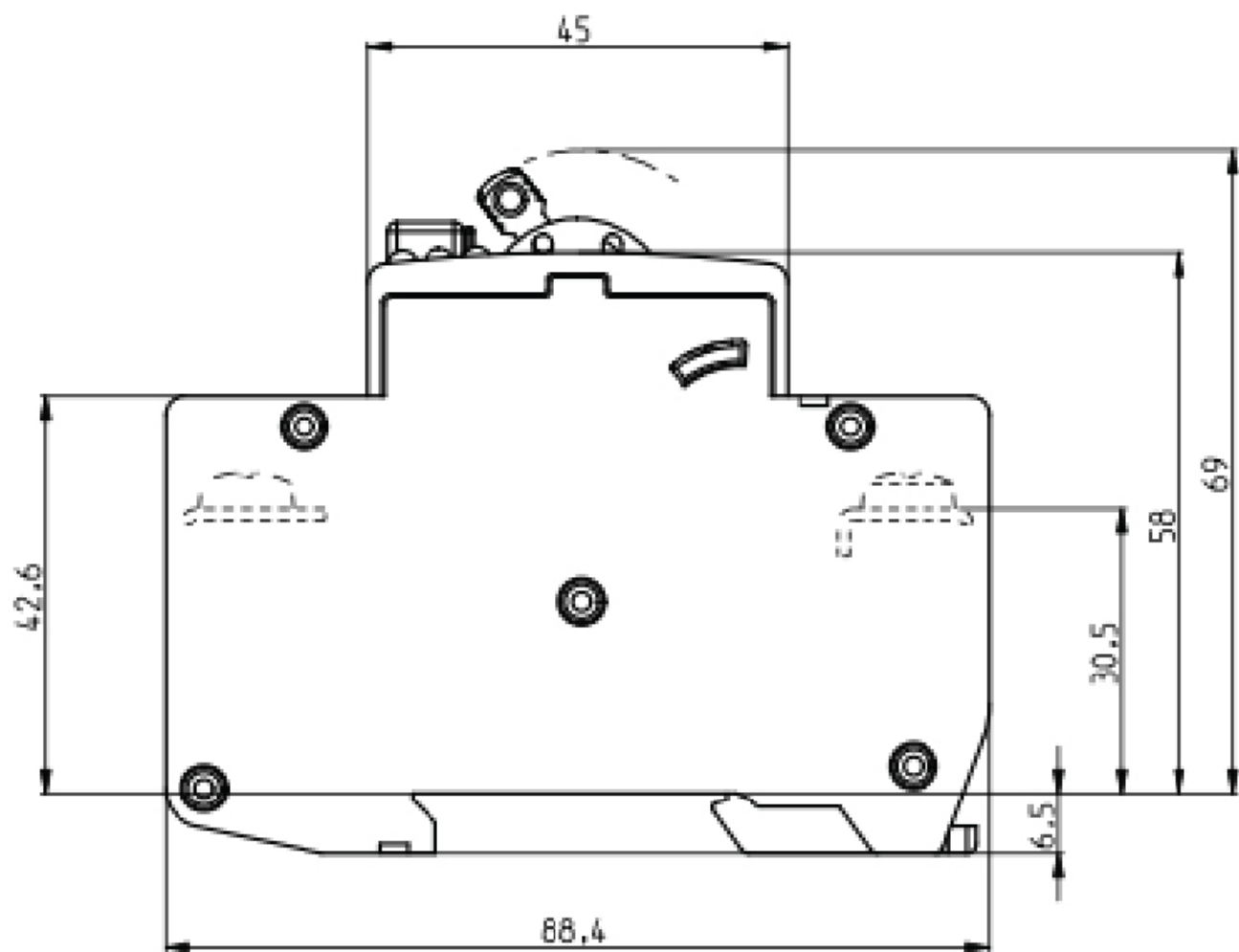

Simbol/Conexiune

