

KVL-00 4p M8-M8



Specificatii

Cod ETI	001690900
Descriere	KVL-00 4p M8-M8
Denumire clasă	Comutator cu siguranță
Curent nominal (A)	160
Tip	KVL
Mărime	NH00
Număr de poli	4
Grup de produse	Separator orizontal pentru siguranțe fuzibile
Tensiune nominală AC (V)	690
Categorie de utilizare	AC-23B / DC-22B
Conectare	M8
Tensiune nominală DC (V)	440
Montare	Screw-on

[Pagina de produse online](#) 

Alta documentatie



[Catalog caracteristici tehnice](#)

[Certificate](#)

[Model 3D](#)

[Manual de instructiuni](#)

[Declaratie CE](#)

[Eplan mușchi](#)

ETIM clasificare internationala

Clasificare	EC001040
Denumire clasă	Fuse switch disconnector
Version as main switch	1
Version as safety switch	1
Rated permanent current Iu	160A
Suitable for fuses	NH00
Number of poles	4
With error protection	
Type of electrical connection of main circuit	Screw connection
Suitable for floor mounting	1
Type of control element	Cover grip

Desen cotat

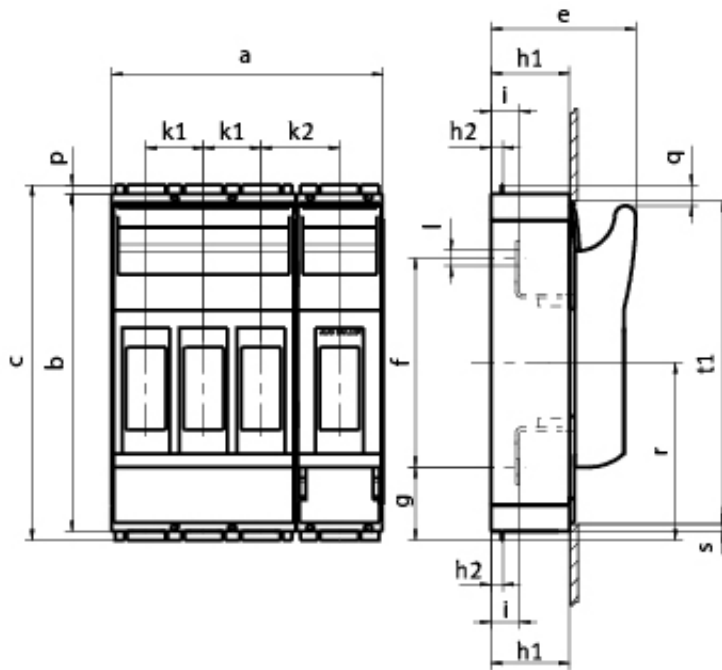

	a	b	c	e	f	g	h1	h2	h3	k1	k2	i	l	p	q	r	s	t1	t2	u
KVL-00 4p M8-M8	156	195	204	84	120	42	45	7	-	33	45	16,5	Ø9	4,5	12	102	5	187	-	-

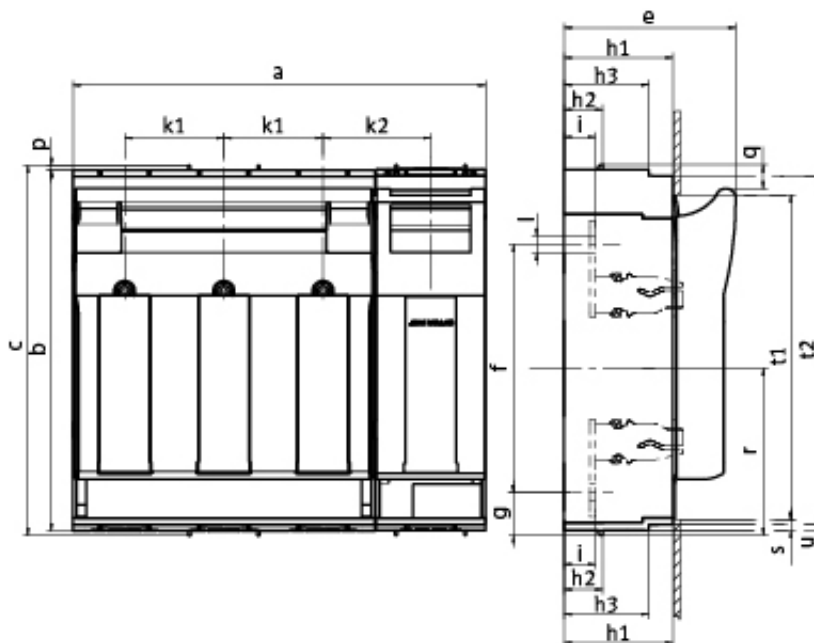

	a	b	c	e	f	g	h1	h2	h3	k1	k2	i	l	p	q	r	s	t1	t2	u
KVL-1 4p	254	298	306	117	185	46	70	32	-	58	69	25	Ø10,5	4	19	138	5	272	-	-
KVL-3 4p	341,5	298	306	143	205	36	90	32	70	82	89	26	Ø14	4	19	138	10	268	288	5