

KVL-00 1p M8-M8



Specificatii

Cod ETI	001690890
Descriere	KVL-00 1p M8-M8
Denumire clasă	Comutator cu siguranță
Curent nominal (A)	160
Tip	KVL
Mărime	NH00
Număr de poli	1
Grup de produse	Separator orizontal pentru siguranțe fuzibile
Tensiune nominală AC (V)	690
Categorie de utilizare	AC-23B / DC-22B
Conectare	M8
Tensiune nominală DC (V)	440
Montare	Screw-on

[Pagina de produse online](#)

Alta documentatie



[Catalog caracteristici tehnice](#)

[Certificate](#)

[Model 3D](#)

[Manual de instructiuni](#)

[Declaratie CE](#)

[Eplan mușchi](#)

ETIM clasificare internationala

Clasificare	EC001040
Denumire clasă	Fuse switch disconnector
Version as main switch	1
Version as safety switch	1
Rated permanent current Iu	160A
Suitable for fuses	NH00
Number of poles	1
With error protection	
Type of electrical connection of main circuit	Screw connection
Suitable for floor mounting	1
Type of control element	Cover grip

Desen cotat

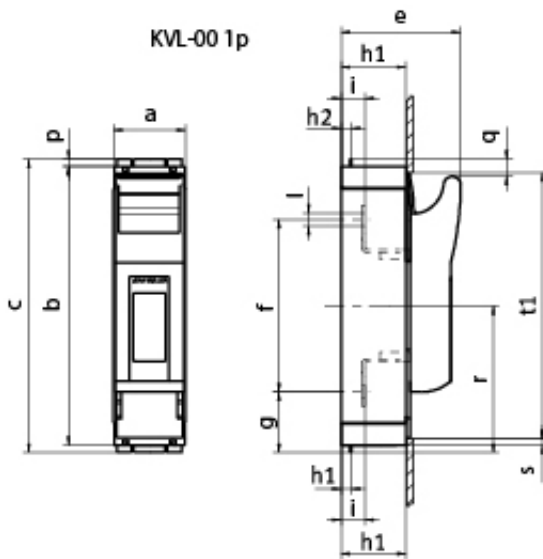

	a	b	c	e	f	g	h1	h2	h3	i	l	p	q	r	s	t1
KVL-00 1p M8-M8	50	195	204	84	120	42	45	7	-	16,5	Ø9	4,5	12	102	5	187
KVL-00 2p M8-M8	100	195	204	84	120	42	45	7	-	16,5	Ø9	4,5	12	102	5	187

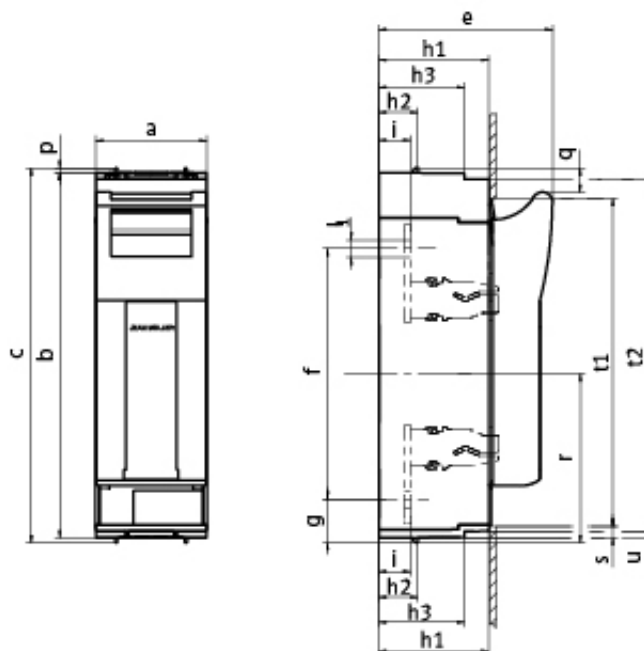

	a	b	c	e	f	g	h1	h2	h3	i	l	p	q	r	s	t1	t2	u
KVL-1 1p M10-M10	69	298	306	117	185	46	70	32	-	25	Ø10,5	4	19	138	5	272	-	-
KVL-3 1p M10-M10	91	298	306	143	205	36	90	32	70	26	Ø14	4	19	138	10	268	288	5